



2025

BLAZER EV PPV & SSV



Preproduction model shown throughout. Actual production model may vary.
2025 Chevrolet Blazer EV PPV available starting fall 2024. Shown with equipment
from independent suppliers not covered by the GM New Vehicle Limited Warranty
GM is not responsible for the safety or quality of independent supplier alterations.



About This Publication

This catalog is not updated during the model year and should not be used for ordering purposes. It is intended as a source of basic information. All illustrations and specifications in this literature are based on the latest product information available at the time of publication. General Motors reserves the right to make changes at any time without notice. For further details, consult your local dealer.

Care must be taken during customer installation of equipment and wiring to ensure that all holes drilled in the body are corrosion protected, properly sealed and that vehicle wiring harnesses, piping or other components have not been displaced or damaged. Aftermarket equipment installers must be mindful of applicable Federal Motor Vehicle Safety Standards. This information can be obtained directly from the National Highway Traffic Safety Administration. Adding non-dealer accessories or making modifications to the vehicle can affect vehicle performance, aerodynamics, and overall top speed. Please return all police vehicles to factory condition and settings upon decommissioning to prevent civilians from using these new 2025 calibrations, lighting and other features intended only for police and emergency customers. Wiring connection or splice changes are to be removed before the vehicle is returned to civilian use.

These vehicles are equipped with an airbag system. The airbag system in your police vehicle includes frontal driver and front outboard passenger airbags, front seat back side impact airbags and roof rail mounted head-curtain airbags. Customer installed equipment such as security barriers behind the front seats should not be mounted so that the barrier ends are within the side airbag deployment zones. The sensors and other components for the airbag system must not be relocated to accommodate the installation of customer furnished equipment; please refer to the service manual for sensor and other component locations. For information concerning instrument panel top pad mounted equipment and airbag system deployment zones, see the airbag information section in this catalog and the vehicle owners manual.

A note about vehicle alterations by independent suppliers: This catalog shows pictures of vehicles that have been altered or upfitted with equipment or components supplied to Chevrolet or its dealers by independent suppliers. GM is not responsible for the safety or quality of design features, materials or workmanship of any alterations by third parties.

INDEX

2025 BLAZER EV POLICE PURSUIT (9C1) DETECTIVE (9C3) AND SPECIAL SERVICE (5W4)*

- **STANDARD FEATURES**
- **OPTIONAL FEATURES**
- **EMISSIONS & TIRES**
- **SPECIFICATIONS**
- **COLORS, EXTERIOR AND INTERIOR**
- **APPROACH AND DEPARTURE ANGLES**
- **SPEEDOMETER/CLUSTER DISPLAY**
- **VEHICLE PERSONALIZATION MENU**
- **STANDARD FEATURES HIGHLIGHTS**
- **OPTIONAL FEATUES HIGHLIGHTS**
- **WIRING DIAGRAMS**
- **AIRBAG DIMENSIONS**
- **NO DRILL / NO CUT ZONES**
- **AIRBAGS FAQ**
- **OnStar® OPTIONS**
- **MAINTENANCE AND LIMITED WARRANTY**



BLAZER EV 9C1 INTERIOR

Shown with equipment from independent suppliers not covered by the GM New Vehicle Limited Warranty GM is not responsible for the safety or quality of independent supplier alterations.



BLAZER EV 9C3/5W4 INTERIOR

UPDATES FOR 2025

NEW OPTIONAL FEATURES

- **Dual level charge cord (PSC)**
- **Special Service Package¹ with Aluminum Wheels (5W4)**
- **Tires, 275/40R22 all-season self-sealing, blackwall. 5W4 only. (QHN) and Wheels, 22" (55.9 cm) machined-face aluminum with carbon flash painted pockets. 5W4 only (PHY)**
- **Brake lining, non-asbestos, organic. 5W4 only (JBO) Brake rotor, FNC. 5W4 only (JCF)**
- **Non-tinted solar absorbing glass (AKP)**
- **GM Envolv Starter Kit (R6Q)**
- **Ship Thru, to Defender Supply (TVU)**

DELETIONS

- **USB ports, 2 type-C. 9C1 only (UBJ)**
- **Dual Level Charge Cord is no longer standard and is now available to order (PSC)**
- **Power outlet, 12-volt, 9C1 only (KH8)**

¹ Late availability

NOTE: Front and rear molded splash guards not available at this time (VQK)

GM restricts the sale of police vehicles, and they are not to be sold to retail customers

The dual motor all-wheel drive Blazer EV Police Pursuit Package has been designed for police work up to, and including, high-Speed emergency vehicle operations. GM restricts the sale of police vehicles, and they are not to be sold to retail customers. Developed for the needs of Law Enforcement, the purpose-built electrical architecture is explicitly prepared for the demands of emergency equipment. A standard 400-volt to 12-volt DC power module is dedicated to emergency equipment demands and is engineered for 100-amps of continuous load. This architecture provides two 20-amp relays in front row with a 30-circuit harness and 50-amp battery feed. One 40-amp, and one 30-amp relay are located in left cargo corner with a 56-circuit harness that shares 25-redundant front signals. 100-amps of battery service and a ground are also standard. Wiring circuits are also included in the front doors to accommodate aftermarket exterior sideview mirror emergency lighting in addition to rear quarter glass wiring provisions. All circuits include a factory connector. A universal vehicle module is provided for CAN readability of selected signals. Model 1MF26 is required when ordering 9C1 or 9C3 Police Package. Content, options and specifications shown are for the police version only which differ from retail civilian models. Speed/Torque Limiter is not available for PPV.

The 9C1 and 9C3 Police Packages includes;

Certified speedometer, heavy duty suspension, under body skid plates, Firestone Firehawk Pursuit tires mounted on 20-inch steel wheels, 6-piston Brembo front calipers on 15.3-inch rotors for increased braking durability and performance during the rigors of a high-speed pursuit.

The 9C1 Marked Police Pursuit Package includes;

Front console delete, black rubberized vinyl floor covering and black cloth front and vinyl rear seating.

The 9C3 Detective Police Package includes;

Retail floor console with armrest, color-keyed carpeting in occupant area and black cloth front and rear seating with cup-holders.

The 5W4 Special Service Package* includes;

22" machined-face aluminum wheels with carbon flash painted pockets, 275/40R22 all-season self-sealing blackwall tires, non-asbestos organic brake lining and FNC brake rotor Police Pursuit. Brake and Tire package is not designed for Pursuit.

STANDARD INTERIOR FEATURES

AIR CONDITIONING	Dual-zone automatic digital climate control. Rear passenger duct located on floor tunnel terminates at back of center console.
AIR FILTER	Pollutant, odor and fine dust.
ARMREST	(9C3 only) Front and rear center console armrest with cupholders.
ASSIST HANDLES	Front passenger and rear outboard.
AUDIO SYSTEM²	17.7" diagonal advanced color LCD display with Google built-in compatibility (select service plan required, terms and limitations apply), including navigation capability, connected apps, personalized profiles for each driver's settings, Natural Voice Recognition and Phone Integration.
BLUETOOTH³	Personal cell phone connectivity to vehicle infotainment system.
CARGO TIE-DOWNS	2 cargo tie-downs in cargo area.
COMPASS	Shown in display.
CONSOLE, FLOOR	Deleted for 9C1 package (reference RPO code DLE), console with armrest for 9C3 and 5W4 package (reference RPO code DO6).
CRUISE CONTROL	Electronic with set and resume speed
DEFOGGER	Rear-window electric
DOOR LOCKS	Power locks for front and rear doors. Rear child security locks.
DRIVER INFORMATION CENTER	11 inch diagonal display
FLOOR COVERING	Black rubberized vinyl floor covering for 9C3 and 5W4 (reference RPO code BG9). Color-keyed carpeting in occupant area with black cloth front and rear seating for 9C3 and 5W4 (reference RPO code B30).
KEY FOB	Two KEYS/FOBS and mechanical keys for ignition and doors. Four additional fobs are available. While unlimited number of learned KEYS/FOBS can operate Keyless start and Keyless open, for a particular vehicle, only the last 8 KEYS/FOBS learned will allow the key fob buttons to work. See Available Options page for ordering codes. See Optional Equipment page for programming procedure.
KEYLESS OPEN	Includes extended range Remote Keyless Entry. If the Key Fob battery is depleted or due to to wireless interference, vehicle may be unlocked using the mechanical key.
KEYLESS START	Includes extended range Remote Keyless Entry.
GLASS	Acoustic, laminated front windshield. Side rear tempered, solar glazing.
GLOVEBOX	Passenger side.
LIGHTING	Front courtesy and dual reading lights. Rear roof, courtesy and dual reading lights.
MICROPHONE, WIRING	Provision located above headliner over driver position for customer supplied microphone and department radio
OnStar[®] SERVICES CAPABLE	See onstar.com for details and limitations. Services vary by model. Service plan required.
OnStar[®] BASICS	OnStar Basics (OnStar Fleet Basics for Fleet) Drive confidently with core OnStar services including select remote commands, built-in voice assistance, real-time traffic and navigation, and Automatic Crash Response to help if you're in need. OnStar Basics includes select remote commands, Navigation, Voice Assistance, and Automatic Crash Response, for eligible vehicles with compatible software. For MY25 vehicles, OnStar Basics is standard for 8 years; OnStar plan, working electrical system, cell reception and GPS signal required. OnStar links to emergency services. Service coverage varies with conditions and location. Service availability, features and functionality vary by device and software version. See onstar.com for details and limitations..
POWER OUTLET	12-volt. Located in the center console compartment for 9C3 and 5W4.

1. Always use seat belts and child restraints. Children are safer when properly secured in a rear seat in the appropriate child restraint. See the Owner's Manual for more information. **2.** Functionality varies by model. Full functionality requires compatible Bluetooth and smartphone, and USB connectivity for some devices. Select service plan required, terms and limitations apply. Go to myChevrolet.com/learn About/bluetooth to find out which phones are compatible with the vehicle. **3.** Go to myChevrolet.com/learn About/bluetooth to find out which phones are compatible with the vehicle.

* Late Availability

STANDARD INTERIOR FEATURES (CONTINUED)

REAR VIEW MIRROR¹	HD Rear Vision Camera. Includes Rear Camera Mirror Washer. Rear Camera Mirror allows user to choose between a traditional rear view mirror or a camera view unobstructed by the vehicle's pillars, trunk, roof, head restraints, rear-seat occupants and other interior aftermarket police equipment.
REAR VISION CAMERA¹	HD Rear Vision Camera shows you a high-resolution digital image of the area directly behind your vehicle when in Reverse to help you park and avoid vehicles and objects. You can also display an overlay of where your vehicle is heading.
SEATS, FRONT	Police specific black cloth bucket seats, driver 8-way power, passenger 6-way power, driver and passenger 2-way power lumbar
SEATS, REAR	60/40-split, fold-flat. 9C1 in vinyl, 9C3 and 5W4 in cloth with center armrest & cup holders.
SIRIUSXM WITH 360L	Includes a trial subscription to the Platinum Plan. Requires (UE1) OnStar. The SiriusXM trial package is not provided on vehicles that are ordered for Fleet Daily Rental ("FDR") use. Trial subscription subject to the SiriusXM Customer Agreement and privacy policy, visit www.siriusxm.com which includes full terms and how to cancel. All fees, content, features, and availability are subject to change. Some features require GM connected vehicle services.
STEERING COLUMN	Tilt and telescopic.
STEERING WHEEL CONTROLS	Audio, Driver Information Center and phone interface controls
TEEN DRIVER¹	A configurable feature that lets you activate customizable vehicle settings associated with a key FOB, to help encourage safe driving behavior. It can limit certain available vehicle features, and it prevents certain safety systems from being turned off. An in-vehicle report card gives you information on driving habits and helps you to continue to coach your new driver. Can be turned off in in your vehicle's Settings menu.
TEMPERATURE DISPLAY	Outside temperature. Cabin humidity and windshield temperature sensor.
THEFT DETERRENT SYSTEM	Unauthorized entry alert and immobilizer.
TPMS	Tire Pressure Monitoring System with auto learn and Tire Fill Alert.
UNIVERSAL VEHICLE MODULE	Provides CAN Readability of selected messages utilizing SAE J1939 formatting. This gateway module offers 10-switchable inputs and outputs, and includes a graphical user interface available to customize specific needs with more than 90 operating parameters available to read.
USB CHARGING PORTS	For 9C3 only. 2 type-C located forward of cupholders, 2 Type-C located within the center console armrest bin and 2 charge only type-C located on back of center console.
VENT	Rear Console, air. 9C3 only.
VISORS	Driver and front passenger illuminated sliding vanity mirrors, covered.
WINDOWS, POWER	Power driver and passenger with Express-Up/Down. Power rear with Express-Down.

STANDARD EXTERIOR FEATURES

ANTENNA	Roof-mounted shark fin (black).
CALIBRATION TAILLAMP	SLO Calibration for taillamp flasher, Red/Red. For detailed technical information on activation of this feature, refer to the vehicle technical guide under the Body Builder Manuals section on www.gmupfitter.com .
CALIBRATION TAILLAMP	SJ9 Calibration for taillamp flasher Red/White. For detailed technical information on activation of this feature, refer to the vehicle technical guide under the Body Builder Manuals section on www.gmupfitter.com .
CHARGE PORT	Manual
DEFOGGER	Electric, rear window
DRL	Day Time Running Lights. See option code 9G8 for permanent delete.
DOOR HANDLES	Body color
FRONT GRILLE	Gloss black
FLASHER SYSTEM	Headlamp and taillamp, DRL compatible with individual control wires.
FOG LAMPS	Not available
GLASS	Acoustic, laminated front windshield. Solar Absorbing rear side window and rear quarter panel window. Tinted rear liftgate window.
HEADLAMPS	LED with automatic on and off.
LICENSE PLATE	Front mounting package (included on orders with ship-to states that require front license plate)
LUGGAGE RACK	Not available. Roof rails deleted.
MIRROR CAPS	High gloss black
MIRRORS, OUTSIDE	Outside heated, power-adjustable, power-folding, driver-side auto-dimming with turn signal indicators.
MOLDING	Door upper. Low gloss black.
REAR CAMERA WASHER	Included with Rear Camera Mirror.
REAR LIFTGATE	Manual
RECOVERY HOOK²	One Threaded eye-bolt shipped loose for use on front or rear of vehicle.
SPLASH GUARDS	Front and Rear molded splash guards. Not available at this time.
TIRES	Firestone Firehawk Pursuit 265/50R20 all-season, V-rated, blackwall, (see standard features illustrations section)
TIRE, SPARE	Standard Inflator Kit, Spare Tire And Jack Assembly Not Available.
WHEELS	20" (50.8 cm) steel with bolted-on aluminum black center cap with black finish.
WINDSHIELD	Solar absorbing shaded upper with acoustic laminated glass
WIPERS, WINDSHIELD	Front intermittent with Rainsense.
WIPER, REAR	Rear intermittent

1. Safety or driver assistance features are no substitute for the driver's responsibility to operate the vehicle in a safe manner. The driver should remain attentive to traffic, surroundings and road conditions at all times. Visibility, weather, and road conditions may affect feature performance. Read the vehicle's owner's manual for more important feature limitations and information.

2. To avoid the risk of injury, never use Recovery Hooks to tow a vehicle. For more information, see the Recovery Hooks section of your Owner's Manual.

STANDARD ELECTRICAL FEATURES

BATTERY, DRIVE	Ultium Propulsion, 102 kWh Battery Rated Energy, 190 kW DC fast charging capable.
BATTERY, SERVICE	12V/60AH, 680 ENCCA
ELECTRONIC PRECISION SHIFT	The electronic precision shift includes an electric parking brake. In the event of a loss of 12-volt battery power, the electric parking brake cannot be released, and the vehicle cannot be shifted to N (Neutral). Tire skates or dollies must be used under the non-rolling tires to prevent damage while loading/unloading the vehicle. Dragging the vehicle will cause damage not covered by the vehicle warranty.
FLEET CONNECTED ACCESS	OnStar and Chevrolet connected services capable, includes (U5G) 5G Wi-Fi Hotspot capable, (U2K) SiriusXM with 360L, (NAM) Google Automotive Services capable, (IMP) smartphone app remote start. Service varies with conditions and location. Requires active service plan and paid AT&T data plan. See OnStar.com/BusinessSolutions for details and limitations. Availability subject to change. Vehicle must be on or in the accessory position for Wi-Fi to function.
RADIO SUPPRESSION	The Blazer EV PPV systems are designed to prevent unwanted emissions and to minimize susceptibility and maximize immunity to external emissions (Electromagnetic (EMI) or Radio Frequency (RFI) Interference). Most emergency vehicle communications equipment operating at frequencies in the VHF Band (30-300 MHz) and up to frequencies in the UHF Band (300 MHz-3GHz) will function as intended without enhanced noise suppression.
REMOTE PANIC ALARM	Keyless remote panic button activates horn and flashing exterior lights. Can be disabled with optional 5J1 calibration.
REMOTE START	Key Fob activated. Included and only available with (UE1) OnStar.
SURVEILLANCE MODE	Calibration to shut-down non-federally mandated exterior and interior lighting. Exterior lighting will shut off only if in auto mode and not equipped with optional LIGHTING DELETE (9G8). Cluster and PRND indicator dimmed to the minimum setting. Brake, reverse and turn signal lighting will override calibration and function if operated. For detailed technical information on activation of this feature, refer to the vehicle technical guide under the Body Builder Manuals section on www.gmupfitter.com.
UPFITTER WIRING PROVISIONS	See WIRING Section for Circuit Diagrams and connector information.
ONE PEDAL DRIVING¹	Helps convert the vehicle's kinetic energy into energy stored in the battery for later use to help get the most range.
HANDS-FREE START	Push the brake pedal after closing the door to start vehicle. The key fob authorizes the hands-free start system.
REGEN ON DEMAND^{TM1}	Helps convert the vehicle's kinetic energy into energy stored in the battery for later use to help get the most range.
RETAINED ACCESSORY POWER	If the vehicle is shifted to Park, the vehicle will turn off when driver exit is detected. Retained Accessory Power (RAP) will remain active until the driver door is opened.
ULTIFI²	Separates the vehicle's software from the hardware to enable the frequent and seamless delivery of software-defined features, apps and services to customers over the air. Ultifi allows customers to continue to upgrade and personalize their vehicle as improvements and new features become available over time.
USB POWER, FRONT	USB 12-volt Not available for 9C1. Located in the center console compartment for 9C3 and 5W4. 2 type C USB ports located forward of the cup holders, USB 2 type C USB located on back of center console, charge only and USB port type C located within center console armrest bin. Not available for 9C1.

STANDARD MECHANICAL FEATURES

BRAKES	Front Brembo performance disc brakes with non-FNC rotors.
COOLING	Heavy-duty
SKID PLATES	Steel front and rear
STEERING	Power, non-variable ratio, electric.
SUSPENSION	Performance
TRANSMISSION	Ultium Performance Dual Motor All Wheel Drive System.
TRACTION CONTROL	Electronic

STANDARD SAFETY FEATURES

AIRBAGS⁴	Frontal, knee and seat-mounted side-impact for driver and front passenger, and roof-rail mounted head-curtain for outboard seating positions. Includes Passenger Sensing System for front passenger.
BUCKLE TO DRIVE	Prevents vehicle from being shifted out of Park until driver seat belt is fastened; times out after 20 seconds and encourages seat belt use, can be turned on and off in Settings or Teen Driver menu This feature is defaulted off for 9C1, 9C3 and 5W4 but can be turned on in the Infotainment menu.
LATCH SYSTEM⁴	(Lower Anchors and Tethers for CHildren), for child child restraint seats.
REAR SEAT REMINDER⁴	Rear Seat Reminder does not detect people, animals or objects in the back seat. It only registers when a rear door has been opened. Can be turned off in in your vehicle's Settings menu.
SAFETY ALERT SEAT³	Safety Alert Seat uses left-, right- or both-side driver seat vibration pulses to help you detect and identify the direction of potential crashes. You can also switch to beeping crash avoidance alerts.
SEAT BELTS⁴	3-point, all positions, includes front and rear seat belt pretensioners
SEAT BELT INDICATORS⁴	Driver, front passenger and rear passengers.
STABILITRAK	Stability Control System with Proactive Roll Avoidance and traction control, includes electronic trailer sway control and hill start assist.
REAR PARK ASSIST³	Rear Park Assist provides alerts of nearby detected vehicle and objects behind your vehicle to help you park and avoid collisions.

1. Feature may be limited when the battery temperatures are extremely cold or hot or when battery is near full charge. See Owner's Manual for details. **2.** Ultifi is pre-production and is subject to change. Actual features, functionality, and product limitations may vary. **3.** Safety or driver assistance features are no substitute for the driver's responsibility to operate the vehicle in a safe manner. The driver should remain attentive to traffic, surroundings and road conditions at all times. Visibility, weather, and road conditions may affect feature performance. Read the vehicle's owner's manual for more important feature limitations and information. **4.** Always use seat belts and child restraints. Children are safer when properly secured in a rear seat in the appropriate child restraint. See the Owner's Manual for more information.



STANDARD HEAVY-DUTY STEEL WHEEL WITH FIRESTONE FIREHAWK PURSUIT TIRE

STANDARD 9C1, 9C3 TIRES

MANUFACTURER	QUANTITY	SIZE	SPEED RATING	TYPE
Firestone	4	265/50R20	V	All-Season Firehawk Pursuit Blackwall

NOTE:

Due to specific requirements for performance durability and safety, GM recommends only the original equipment tires for replacement.

Tire Plies = Tread 6 ply; 2 Polyester, 2 Steel, 2 Nylon, Sidewall, 2 Polyester

Tire Chains - If the vehicle is equipped with tire size 265/50R20, use tire winter traction devices only where legal and only when necessary. Only use textile traction devices, such as tire snow socks, that are the proper size for the tires. Traction devices must be installed only on the tires of the drive axle. Drive slowly and follow the traction device manufacturer's instructions. Driving too fast or spinning the wheels can damage the traction device.

OPTIONAL INTERIOR FEATURES

U5G	5G WI-FI HOTSPOT - Included and only available with (UE1) OnStar. Terms and limitations apply. See onstar.com or dealer for details. Service varies with conditions and location. Requires active service plan and paid AT&T data plan. See OnStar.com/BusinessSolutions for details and limitations. Availability subject to change. Vehicle must be on or in the accessory position for Wi-Fi to function.
NAM	GOOGLE AUTOMOTIVE SERVICES - included and only available with (UE1) OnStar.
6E2	KEYS/FOBS - Fleet Calibration, provides a single key and calibration with a specific code that is common to the driver door lock of the entire Blazer EV fleet with the same code. Key code is an alternate to SEO (6E8) Fleet Calibration. Includes (AU7) common fleet key. Requires (AMF) Remote Keyless Entry Package. Not available with SEO (6E8) complete vehicle fleet common key.
6E8	KEYS/FOBS - Fleet Calibration, provides a single key and calibration with a specific code that is common to the driver door lock of the entire Blazer EV fleet with same code. Key code is an alternate to SEO (6E2) Fleet Calibration. Includes (AU7) common fleet key. Requires (AMF) Remote Keyless Entry Package. Not available with SEO (6E2) complete vehicle fleet common key.
AMF	REMOTE KEYLESS ENTRY PACKAGE - Includes 4 additional transmitters, NOTE: programming of remotes is at customer's expense. Programming remotes is not a warranty expense.
T53	LAMPS - Alternate flashing Red & Blue rear compartment lid warning (visible when liftgate is open) and controlled by momentary liftgate mounted switch or ground wire.
VAV	FLOOR MATS - All-weather floor mats (not available on 9C1)
6C7	LIGHTING - Red and white LED auxiliary dome lamp is located on headliner between front row seats. The auxiliary lamp is wired independently from standard dome lamp.
6N6	REAR DOOR LOCKS AND HANDLES INOPERATIVE - Rear power locks are inoperable at rear door but operate from drivers position, rear doors can be opened only from outside the vehicle. Includes (VBO) Kerr Industries Ship-thru to mechanically remove hardware linkage.
6N5	REAR DOOR WINDOW SWITCHES INOPERATIVE - Calibration for rear windows to operate from drivers position only. Window lockout switch remains illuminated in all positions when equipped with this feature.

OPTIONAL EXTERIOR FEATURES

9G8	LIGHTING DELETE - Daytime Running Lamps and automatic headlamp control delete. Deletes standard Daytime Running Lamps and automatic headlamp control features, also disables automatic interior courtesy lighting.
5T4	SPECIAL PAINT - Victory Red WA 9260. Requires SEO (TGK) special paint solid.
9W5	SPECIAL PAINT - Silver Ice Metallic WA 636R. Requires SEO (TGK) special paint solid.
9V7	SPECIAL PAINT - Dark Blue Metallic WA 722J. Requires SEO (TGK) special paint solid.
9V2	SPECIAL PAINT - MSP Blue Goose.
6JE	BLUE LEFT / BLUE RIGHT WHELEN LED ION LIGHT PACKAGE - Two ION light heads mounted on each exterior corner. Not available with 6JG, 6J9 or 6J8 Package.
AKP	LIFTGATE GLASS - Solar absorbing, non-tinted rear liftgate glass. Replaces tinted rear liftgate glass (AKO).
ARU	REAR GLASS - Tinted rear window and rear quarter panel glass. Replaces solar absorbing non-tinted, rear window and rear quarter panel glass (ARS).
6JG	RED LEFT / BLUE RIGHT WHELEN LED ION LIGHT PACKAGE - Two ION light heads mounted on each exterior corner. Not available with 6JE, 6J9 or 6J8 Package.
6J9	RED LEFT / RED RIGHT WHELEN LED ION LIGHT PACKAGE - Two ION light heads mounted on each exterior corner. Not available with 6JG, 6JG or 6J8 Package.
6J8	WHITE LEFT / WHITE RIGHT WHELEN LED ION LIGHT PACKAGE - Two ION light heads mounted on each exterior corner. Not available with 6JG, 6J9 or 6J9 Package.
TGK	SPECIAL PAINT SOLID - Special paint, one color. Required with any special paint selection. Refer to individual special paint SEO codes for details on body colored non-sheet metal parts. May require extended lead time.
7X3	SPOTLAMP - Left hand, pillar-mounted unity, 6-inch with LED lamps; independently fused NOTE: Factory installation of spotlamps are recommended. Special tooling is used to locate and drill the spotlamp shaft hole in the pillars. (Interior trim covers provided with factory installed lamps are not available as service parts). Field installation of spotlamps must not interfere with proper deployment of the roof rail mounted head-curtian airbags in the event of a crash.

OPTIONAL ELECTRICAL FEATURES

5J1	CALIBRATION - Disables the following standard features: Entry Lighting and Exit Lighting, Remote Keyless Entry Feedback (Horn Beep, Lamps Flash, and Panic Alarm).
PSC	DUAL LEVEL CHARGE CORD - Includes dual-mode, portable, 120-volt (1.4 kW) and 240-volt (7.7 kW) capability, swappable nema 5-15 and NEMA 14-50 plugs with SAE J1772 vehicle connection.
1MP	SMARTPHONE APP REMOTE START - Only available with OnStar.
UTQ	THEFT DETERRENT SYSTEM DISABLE - The alarm and horn become non-functional in an attempt of theft to the vehicle (recommended for vehicles utilizing 6E2 or 6E8 key codes).
WX7	WIRING - Auxiliary speaker. For upfitter connection to front door and windshield speakers.
6J3	WIRING - For grille lamps and siren speaker
6J4	WIRING - For horn and siren.

OPTIONAL MECHANICAL FEATURES

- R6Q GM ENVOLVE STARTER KIT I** - Provides customers and drivers with access to comprehensive training and educational content on EV. topics Requires one of the following Fleet or Government order types: FLS, FNR, FRC, FBC, FGO or FEF. Requires one of the following OnStar Insights services: (POV) 12 Months, (POW) 24 Months, (POX) 36 Months, (POY) 48 Months, or (POZ) 60 Months. Not available with a ship-to of Guam, Puerto Rico or the Virgin Islands.

- 5W4 STREET APPEARANCE PACKAGE** - 22" machined-face aluminum wheels with carbon flash painted pockets, 275/40R22 all-season self-sealing blackwall tires, non-asbestos organic brake lining and FNC brake rotor Police Pursuit. Brake and Tire package is not designed for Pursuit. Requires 9C3 Package which includes retail floor console, armrest, color-keyed carpeting in occupant area and black cloth front and rear seating with cup-holders.

- V92 TRAILERING PROVISIONS** - Includes; Wiring, (CTT) Hitch Guidance and (PZ8) Hitch View

- SDE TRAILER HITCH** - Removable 2" (Class 2.) receiver. Requires (V92) trailering provisions and (VLG) trailer hitch trim bezel.

- VLG TRAILER HITCH TRIM BEZEL** - Dealer installation trim. Requires (SDE) trailer hitch.

OPTIONAL SHIP THRU

- VBO SHIP THRU** - Produced in GM Ramos and shipped to Kerr Industries Ramos, Returned to GM Ramos for shipping to final destination. Included with (6C7) Red and white LED auxiliary dome lamp, (6J8) White Left/White Right Whelen ION LED Lamp Package, (6J9) Red Left/Red Right Whelen LED ION Lamp Package, (6JE) Blue Left/Blue Right Whelen LED ION Lamp Package, (6JG) Red Left/Blue Right Whelen LED ION Lamp Package, (6N6), inside rear doors inoperative door locks and handles, (7X3) left-hand, LED spotlight and (T53) alternate flashing Red & Blue rear compartment lid warning lamps.

- (TVU) SHIP THRU** - Produced in GM Ramos and shipped to Defender Supply. Shipped from Ramos to Argyle location for upfit and back to Arlington for final destination.

- (TBP) SHIP THRU** - Produced in GM Ramos and shipped to Kerr Industries of Texas, Returned to GM Arlington Plant for shipping to final destination.



5W4 SPECIAL SERVICE STREET APPEARANCE PACKAGE

OPTIONAL 5W4 WHEELS AND TIRES

MANUFACTURER	QUANTITY	SIZE	SPEED RATING	TYPE
Michelin	4	265/40R22	V	All-Season Self-Sealing Blackwall

NOTE:

Due to specific requirements for performance durability and safety, GM recommends only the original equipment tires for replacement.

EMISSIONS - ZERO EMISSIONS VEHICLE (ZEV)

FE9	Emissions. Federal requirements
NE1	Emissions. Colorado, Connecticut, Delaware, Maine, Maryland, Massachusetts, Minnesota, Nevada, New Jersey, New York, Oregon, Pennsylvania, Rhode Island, Vermont, Virginia and Washington state requirements
YF5	Emissions. California state requirements
NB8	Emissions override. California (allows a dealer in states that require California emissions - California, Colorado, Connecticut, Delaware, Maryland, Massachusetts, Minnesota, Nevada, New Jersey, New York, Oregon, Pennsylvania, Rhode Island, Virginia or Washington - to order Federal emissions for a vehicle that will be registered in a state that has Federal emission requirements). Do not use for vehicles that will be registered in California, Colorado, Connecticut, Delaware, Maryland, Massachusetts, Minnesota, Nevada, New Jersey, New York, Oregon, Pennsylvania, Rhode Island, Virginia or Washington.
NB9	Emissions override, state-specific (for dealers ordering vehicles in (YF5) or (NE1) emission states - California, Colorado, Connecticut, Delaware, Maine, Maryland, Massachusetts, Minnesota, Nevada, New Jersey, New York, Oregon, Pennsylvania, Rhode Island, Vermont, Virginia and Washington)". Also updated footnote 1 to now read "Allows a California dealer (YF5 emissions) to order (NE1) emissions with (NB9) emissions override code for registration in (NE1) states; or, a Colorado, Connecticut, Delaware, Maine, Massachusetts, Minnesota, Nevada, New Jersey, New York, Oregon, Pennsylvania, Rhode Island, Vermont, Virginia and Washington dealer (NE1 emissions) to order (YF5) emissions with (NB9) emissions override code for registration in California.
NC7	Emissions override, Federal (for vehicles ordered by dealers in Federal emission states with (YF5) or (NE1) emissions - Not required for vehicles being shipped to California, Colorado, Connecticut, Delaware, Maine, Maryland, Massachusetts, Minnesota, Nevada, New Jersey, New York, Oregon, Pennsylvania, Rhode Island, Vermont, Virginia or Washington)". Also updated footnote 1 to now read "Requires (YF5) California state emissions requirements or (NE1) Colorado, Connecticut, Delaware, Maine, Massachusetts, Minnesota, Nevada, New Jersey, New York, Oregon, Pennsylvania, Rhode Island, Vermont, Virginia or Washington state emissions requirements.

FE9 NAME CERTIFICATION EMISSION, FEDERAL
 NE1 NAME CERTIFICATION EMISSION, GEOGRAPHICALLY RESTRICTED
 YF5 NAME CERTIFICATION EMISSION, CALIFORNIA is certified to EPA Tier 3 BIN 70 standards and qualifies as ULEV 70 (Ultra Low Emission Vehicle) under California Air Resources Board (CARB) requirements, meaning it is 50-state certified.
 EPA engine family or test group: MGMXT05.3388

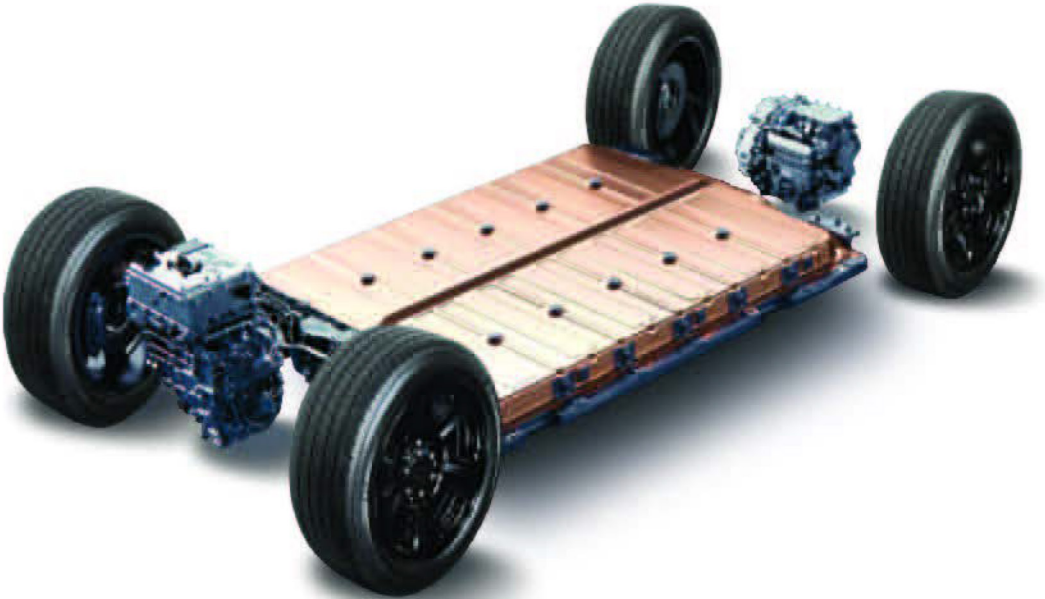

ULTIUM PLATFORM

SPECIFICATIONS

DUAL MOTOR ALL WHEEL DRIVE (MPH/KPH)

Model	1MF26
Projected top speed ¹	130/209
Projected top speed in reverse	25/40
Projected distance to reach top speed ¹ (miles/km)	0.76/1.22
Acceleration ¹ 0-20 mph (sec.)	1.66
Acceleration ¹ 0-30 mph (sec.)	2.48
Acceleration ¹ 0-40 mph (sec.)	3.30
Acceleration ¹ 0-50 mph (sec.)	4.13
Acceleration ¹ 0-60 mph (sec.)	5.08
Acceleration ¹ 0-70 mph (sec.)	6.21
Acceleration ¹ 0-80 mph (sec.)	7.59
Acceleration ¹ 0-90 mph (sec.)	9.27
Acceleration ¹ 0-100 mph (sec.)	11.23

RANGE ON A FULL CHARGE

GM Estimated range without Emergency Equipment ⁷ (miles/km)	297/478
GM Estimated range with Emergency Equipment ⁷ (miles/km)	274/441

Note: EPA-ESTIMATED ratings are official, not estimate based on GM testing

VEHICLE WEIGHT (LBS./KG.)

Seating Capacity	2/3
GVWR ³ (Gross Vehicle Weight Rating)	6945/3150
FGAWR (Front Gross Axle Weight Rating)	1550/703
RGAWR (Rear Gross Axle Weight Rating)	1700/771
Payload ⁴	904/410
Base curb weight	5870/2663
Maximum Trailering Capacity ⁵	1,000/454

PASSENGER COMPARTMENT VOLUME (cu.ft./liters)

Passenger Volume Front Row	58/1642
Passenger Volume Second Row	25.7/728
Cargo Volume With Rear Seat Up	26.2/742

FRONT COMPARTMENT (in./mm)

Head room	40.88/1038
Shoulder room, 1st row	58.70/1491
Hip room, 1st row	57.40/1458
Leg room, 1st row, max	44.20/1123

REAR COMPARTMENT (in./mm)

Head room	38.10/968
Shoulder room	58.33/1482
Hip room	53.79/1366
Leg room	38.92/989

CARGO (in./mm)

Load floor length to center of front seat at floor	71/1804
Load floor length to center of 2nd seat at floor at seat	25/889
Inside width between wheelhouse	42/1067
Cargo area width	47.2/1200
Cargo area length	36.9/937
Cargo area height (headliner limited)	26.8/681
Cargo volume ² maximum behind front seat (cu. ft./liters)	59.1/1673.7
Cargo volume ² maximum behind second seat (cu. ft./liters)	25.5/722.2

EXTERIOR (in./mm)

Wheelbase	121.80/3094
Overall length	192.62/4893
Overall width, without mirrors	78.02/1982
Overall width, including mirrors	86.50/2197
Overall height ⁶	64.78/1645
Lift in height ⁶ (Top of load floor to ground)	29.40/747
Front track width	65.90/1674
Rear track width	65.90/1674
Turning diameter curb to curb (ft./m)	39.7/12.1
Approach angle	19 degrees
Departure angle	22 degrees
Breakover angle	15 degrees
Ground Clearance	6.5/166
Overhang, front	35.09/891
Overhang, rear	35.37/898
Fording depth	12in/304.8mm @ 6.2mph/10kph

1. Based on 2025MY Michigan State Police Vehicle Test Results. All vehicles tested with clean roof and no additional equipment or added ballast. Adding non dealer accessories or making modifications to the vehicle can affect vehicle performance, aerodynamics, overall top speed and acceleration. **2.** Cargo and load capacity limited by weight and distribution. **3.** Gross Vehicle Weight Rating (GVWR). When properly equipped, includes vehicle, passengers, cargo and equipment. **4.** These maximum payload ratings are intended for comparison purposes only. Before you buy a vehicle or use it to haul people or cargo, carefully review the vehicle loading section of the Owner's Manual and check the carrying capacity of your specific vehicle on the label on the inside of the driver's door jamb. **5.** Maximum trailering ratings are intended for comparison purposes only. Before you buy a vehicle or use it for trailering, carefully review the trailering section of the Owner's Manual. The trailering capacity of your specific vehicle may vary. The weight of passengers, cargo and options or accessories may reduce the amount you can trailer. **6.** Published dimension indicated is from ground and without optional equipment or accessories. Additional accessories or equipment ordered at the customer's request can result in a minor change in this dimension. **7.** On a full charge based on development testing and/or analytical projection consistent with SAE J1634 revision 2017 - MCT. Range subject to change prior to production. Actual range may vary based on several factors, including ambient temperature, terrain, battery age and condition, loading, and how you use and maintain your vehicle. EPA estimates not yet available.

SPECIFICATIONS

PROPULSION SYSTEMS **STANDARD**

Type	Ultium Performance Dual Motor All Wheel Drive
Motor	2-Motor Permanent Magnetic Drive
Power on a full charge (hp/kW)	498/372
Torque on a full charge (lb.ft./Nm)	531/720

DRIVE BATTERY

Type	Rechargeable energy storage system with 12-module pack
Mass (lb / kg)	947 / 430
Battery chemistry	Lithium-ion
Cells	288
Energy	102 kWh
Projected Range(mi/km)	250/402
Warranty ²	8 years / 100,000 miles of battery and electric components coverage

BRAKES

eBoost ABS	Disc/Disc
Front rotor diameter (in./mm)	15/381
Rear rotor diameter (in./mm)	13.5/343
Front rotor thickness (in./mm)	1.26/32
Rear rotor thickness (in./mm)	0.79/20
9C1 Projected Stopping Distance from 60.0 mph (ft.) ⁵	128.16

TIRES

Type	Firestone Firehawk Pursuit, V-rated, All-season
Size	265/50R20

WHEELS

Type	Black Steel with bolt on aluminum center cap
Size	20"x 9"

CHASSIS

Suspension	Heavy-duty police-rated suspension with unique StabiliTrak performance calibration.
Steering type	Power, non-variable ratio, electric
Steering ratio	15.98:1

SERVICE BATTERIES

Type	Maintenance free
BCI group size	LN1
Volts	12 V
Amp hour rating	50 ah
Reserve capacity	80 min
Cold cranking-amps	520 a

LEVEL 1 RESIDENTIAL CHARGING¹

120-Volt (7.7kW/32amps)	Provides up to 17 miles of range per hour
-------------------------	-------------------------------------------

LEVEL 2 RESIDENTIAL CHARGING³

240-Volt (11.5kW/48-amps)	Provides up to 37 miles of range per hour
240-Volt (19.2kW/80-amps)	Provides up to 52 miles of range per hour

LEVEL 3 DC FAST CHARGING⁴

400-Volt 190 Kilowatt	Provides up to 71-miles of range in 10-minutes or 141-miles of range in approximately 30-minutes
-----------------------	--------------------------------------------------------------------------------------------------



DC FAST CHARGING CAPABLE

1. Requires professional installation of a compatible outlet. Actual charge times will vary based on battery starting state of charge, battery condition, output of charger, vehicle settings and outside temperature. See the vehicle's Owner's Manual for additional limitations. **2.** Limited warranty. Whichever comes first. See dealer for details. See owner's manual for additional limitations. **3.** Requires public charge station or professionally installed dedicated charge station, sold separately. Actual charge times will vary based on battery starting state of charge, battery condition, output of charger, vehicle settings and outside temperature. See the vehicle's Owner's Manual for additional limitations. **4.** Requires public DC Fast Charger. Actual charge times will vary based on battery starting state of charge, battery condition, output of charger, vehicle settings and outside temperature. See the vehicle's Owner's Manual for additional limitations. **5.** Based on 2025MY Michigan State Police Vehicle Test Results. All vehicles tested with clean roof and no additional equipment or added ballast. Adding non dealer accessories or making modifications to the vehicle can affect vehicle performance, aerodynamics, overall top speed and acceleration.

AVAILABLE EXTERIOR COLORS ACTUAL COLORS MAY VARY



Summit White
WA-8624



Black
WA-8555



Riptide Blue Metallic
WA-121J



Galaxy Gray Metallic
WA-127J



Radiant Red Tintcoat*
WA-170H

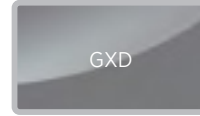

Sterling Gray Metallic
WA-130H

*Available at extra cost

SEO PAINT AVAILABLE¹ ACTUAL COLORS MAY VARY

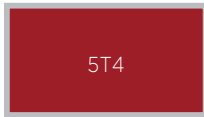

Victory Red
WA-9260

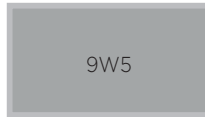

Silver Ice Metallic
WA-636R

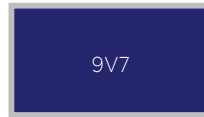

Dark Blue Metallic
WA-722J

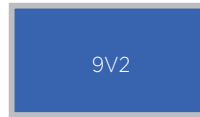

MSP Blue Goose
WA-5665

NOTE:
• Actual color may vary

AVAILABLE INTERIOR COLOR ACTUAL COLORS MAY VARY

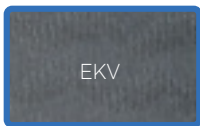

Black cloth Front
Black vinyl Rear
9C1 only

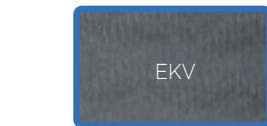
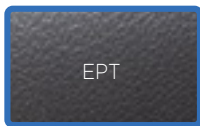

Black cloth Front and Rear
9C3, 5W4 only



Blazer EV 9C1 Interior



Blazer EV 9C3, 5W4 Interior

1. Not available at this time.



REAR ACCOMODATIONS

Shown with equipment from independent suppliers not covered by the GM New Vehicle Limited Warranty GM is not responsible for the safety or quality of independent supplier alterations.

APPROACH AND DEPARTURE ANGLES

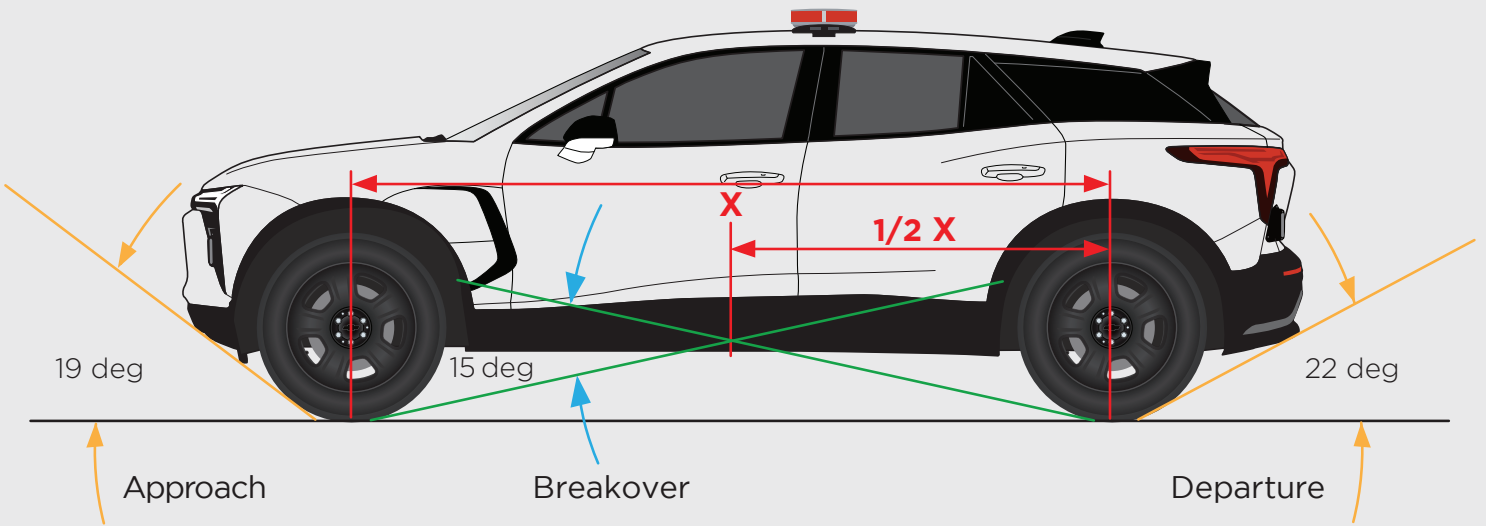

	PPV Blazer EV AWD
Approach Angle	19 degrees
Departure Angle	22 degrees
Breakover Angle	15 degrees
Ground Clearance	7.49 in. / 190 mm
Wheelbase (X)	121.80 in. / 3094 mm
Overhang, front	35.09 in. / 891 mm
Overhang, rear	5.37 in. / 898 mm

DIMENSIONS

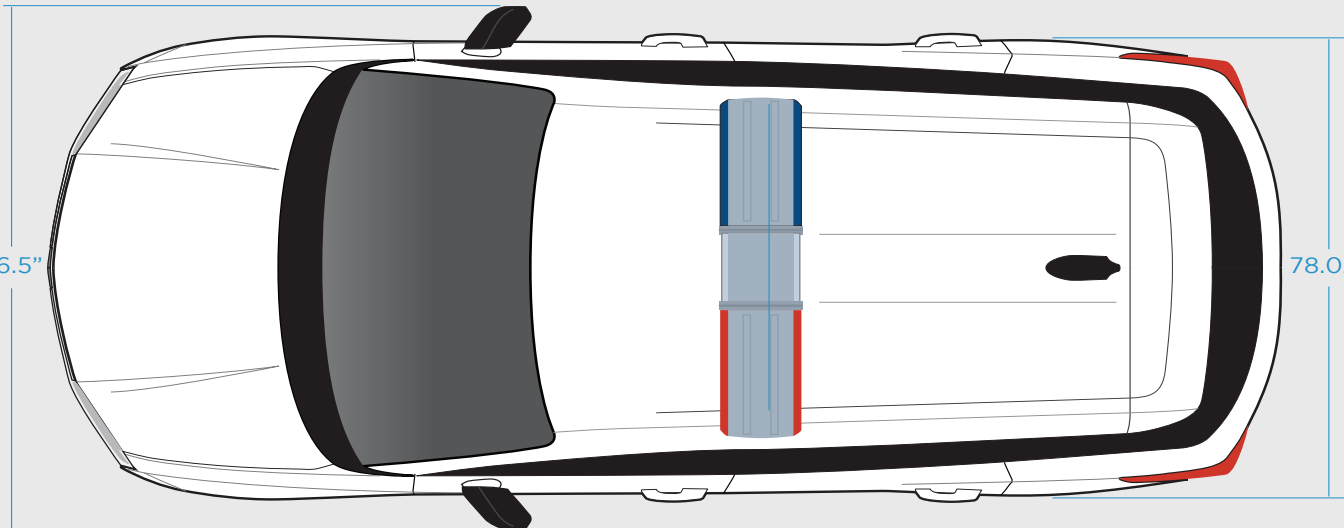
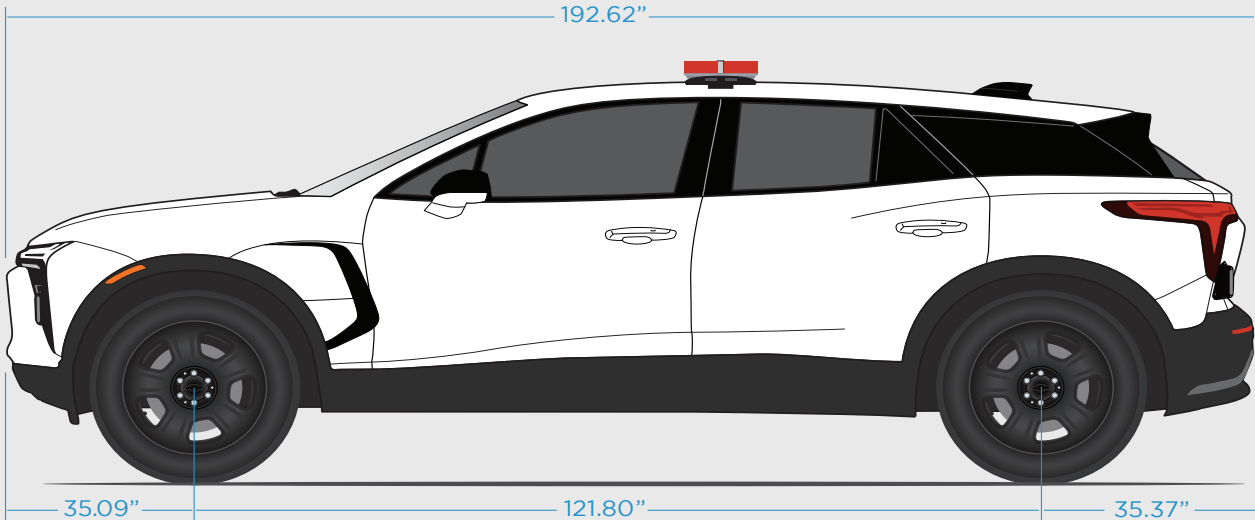

Estimated material sizes to wrap:

- Hood - 50" x 72"
- Front Doors - 57" x 34"
- Rear Doors - 52" x 35"
- Roof - 112" x 60"
- Front Clip - 40" x 115"
- Rear Clip - 38" x 70"
- Front Quarter - 56" x 32"
- Rear Quarter - 42" x 32"

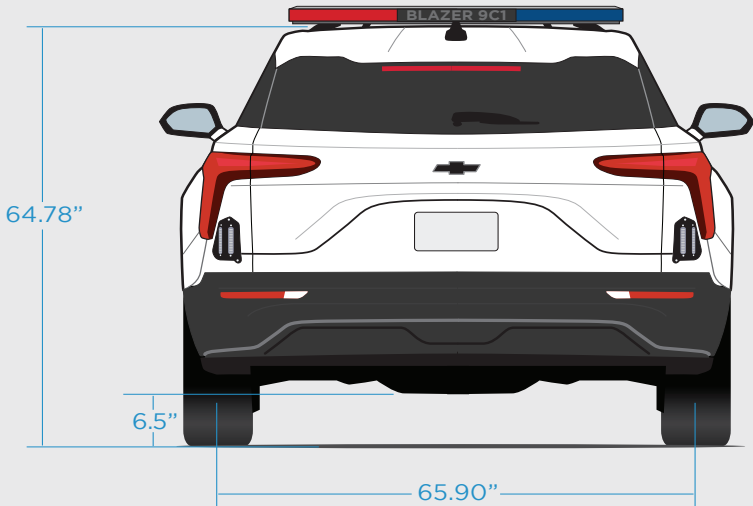

UNITED STATES CERTIFIED SPEEDOMETER/CLUSTER (CANADIAN SIMILAR)

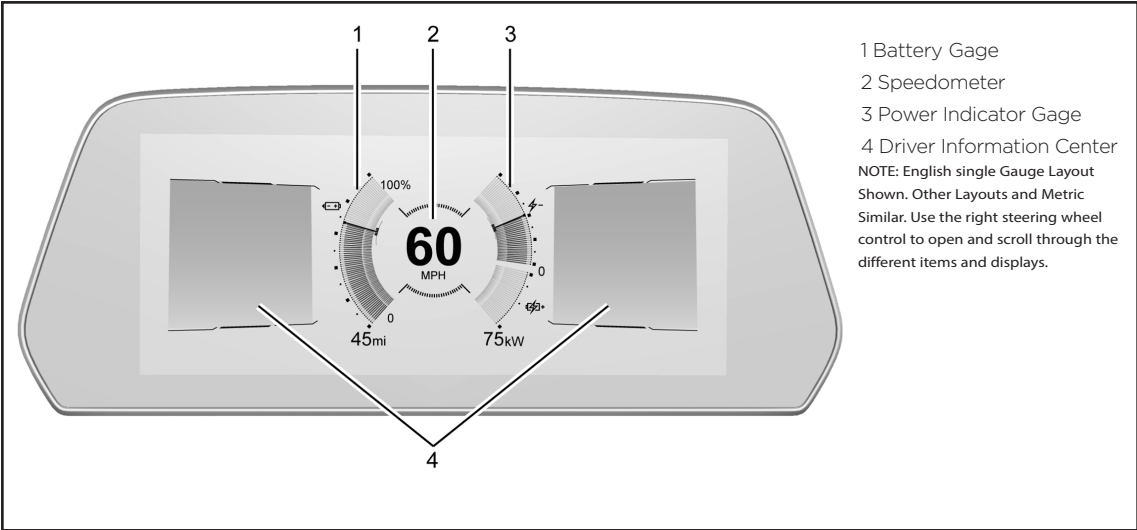

- 1 Battery Gage
 - 2 Speedometer
 - 3 Power Indicator Gage
 - 4 Driver Information Center
- NOTE: English single Gauge Layout Shown. Other Layouts and Metric Similar. Use the right steering wheel control to open and scroll through the different items and displays.

RADIO, SIREN/FLASHERS CONTROLS

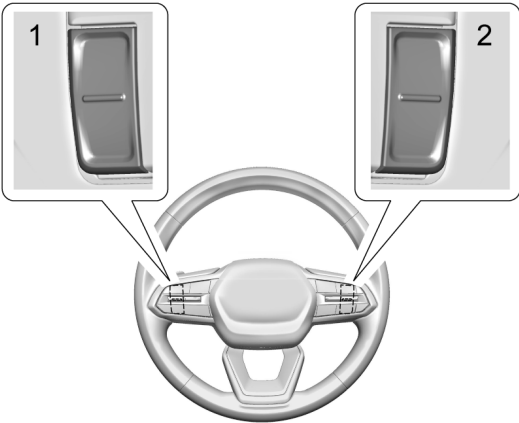

1. The steering wheel controls on left rear side control momentary output for two-way radio microphone and latching for siren/flashers.
2. Volume: Press to increase or decrease the volume.

2025 BLAZER EV PPV SPEEDOMETER CERTIFICATION CALIBRATION

"To Whom it May Concern;

The speedometer system in the 2025MY Police Blazer EV is equipped with an electronically controlled speedometer which is designed to be accurate ± 3 km/h (± 2 mph) through its range of function. The Police Package speedometer is calibrated with (XFD performance dual motor all wheel drive), electrified propulsion system, and 265/50R20 SL 107V rated tires (QH9). Specifications are at temperatures of -23 to 49 °C (-10 to 120 °F). Inaccuracies due to vehicle speed sensing are included.

GM specified vehicle maintenance is required to maintain the stated accuracy of the speedometer system. The accuracy of the speedometer system is dependent on and affected by the required vehicle maintenance including; following placard tire inflation pressure of 39 psi, monitoring tire wear as directed by the owner's manual, tire replacement with all-season Firestone Firehawk Pursuit 265/50 R20 tires, maintaining original OEM driveline ratios, maintaining original OEM electronic module calibration files and following vehicle loading limitations.

Sean O'Shea
Regards,

Sean O'Shea
Police Vehicle Program Manager

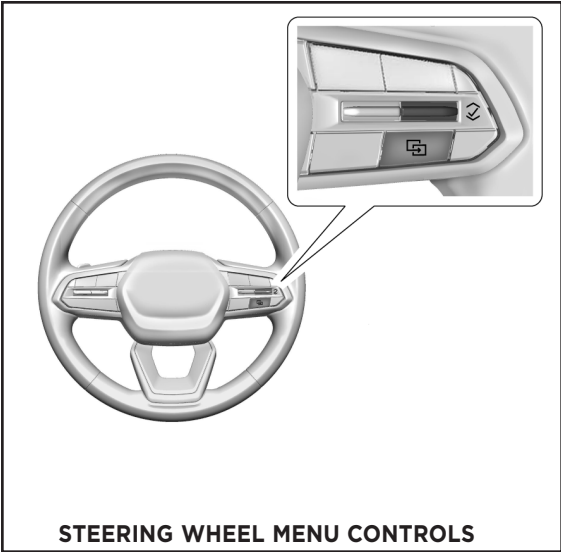

STEERING WHEEL MENU CONTROLS

VEHICLE TOUCH SCREEN SETTINGS



VEHICLE PERSONALIZATION MENU

The Personalization Menu is accessed by:

Item setting

Important features in the VEHICLE SETTINGS sub-menu that can be changed are:

Rear Seat Reminder¹

Buckle to Drive

Collision Detection²

Comfort and Convenience

Lighting

Power Locks

Safety Alert Seat²

See the Owner's Manual for a complete Vehicle Personalization Menu listing of items that may be available for your vehicle.

¹ Does not detect people or items. Always check rear seat before exiting. ² Safety or driver assistance features are no substitute for the driver's responsibility to operate the vehicle in a safe manner. The driver should remain attentive to traffic, surroundings and road conditions at all times. Visibility, weather, and road conditions may affect feature performance. Read the vehicle's owner's manual for more important feature limitations and information.

STANDARD INTERIOR FEATURES



REAR CAMERA MIRROR

Inside rearview auto-dimming with full camera display. Includes (CWA) Rear Camera Mirror Washer.

This automatic dimming mirror provides a wide angle camera view of the area behind the vehicle. Pull the tab to turn on the display. Push the tab to turn it off. When off the mirror is automatic dimming. Adjust the mirror for a clear view of the area behind the vehicle while the display is off.

WARNING: The Rear Camera Mirror (RCM) has a limited view. Portions of the road,

vehicles, and other objects may not be seen. Do not drive or park the vehicle using only this camera. Objects may appear closer than they are. Check the outside mirrors or glance over your shoulder when making lane changes or merging. Failure to use proper care may result in injury, death, or vehicle damage.

The Rear Camera Mirror may not work properly or display a clear image if:

- There is glare from the sun or headlamps.
- This may obstruct objects from view. If needed, push the tab to turn off the display.
- Dirt, snow, or other debris blocks the camera lens. Clean the lens with Rear Camera Washer or a soft damp cloth.
- The camera's mounting on the vehicle has been damaged, and/or the position or the mounting angle of the camera has changed.

Safety or driver assistance features are no substitute for the driver's responsibility to operate the vehicle in a safe manner. The driver should remain attentive to traffic, surroundings and road conditions at all times. Visibility, weather, and road conditions may affect feature performance. Read the vehicle's owner's manual for more important feature limitations and information.

REAR SEAT REMINDER

The message REAR SEAT REMINDER LOOK IN REAR SEAT displays under certain conditions indicating there may be an item or passenger in the rear seat. Check before exiting the vehicle. This feature will activate when a second row door is opened while the vehicle is on or up to 10 minutes before the vehicle is turned on. There will be an alert when the vehicle is turned off. The alert does not directly detect objects in the rear seat; instead, under certain conditions, it detects when a rear door is opened and closed, indicating that there may be something in the rear seat.

The feature is active only once each time the vehicle is turned on and off, and will require reactivation by opening and closing the second row doors. There may be an alert even when there is nothing in the rear seat; for example, if a child entered the vehicle through the rear door and left the vehicle without the vehicle being shut off.

The feature can be turned on or off. Select Settings > Vehicle > Rear Seat Reminder > ON or OFF.

Note: Safety or driver assistance features are no substitute for the driver's responsibility to operate the vehicle in a safe manner. Read the vehicle's Owner's Manual for important safety and driver assistance feature limitations and information

STANDARD SAFETY FEATURES

SAFETY ALERT SEAT¹



The driver seat cushion may provide a vibrating pulse alert or audible beeping. To change settings from the infotainment screen, touch Settings > Vehicle > Collision/Detection Systems. Keep these areas of the vehicle clean and clear of obstacles to ensure the best driver assistance feature performance. Driver Information Center (DIC) messages may display when the systems are unavailable or blocked.

REAR PARK ASSIST¹

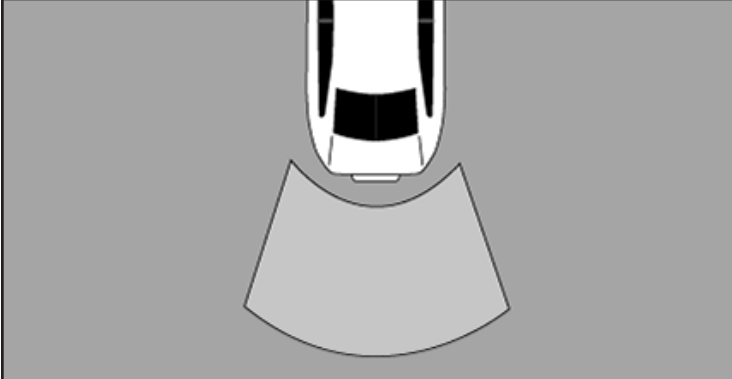

The cluster may display a Park Assist amphitheater-like display with bars that represent the estimated location of a detected object and the vehicle's distance from the object. As a detected object becomes closer, more bars light up and change color from yellow to amber to red. When an object is first detected in the rear, one beep will be heard from the rear, or the SAFETY SEAT will pulse two times. When an object is very close, five beeps will sound from the rear or the SAFETY SEAT will pulse five times.

The Park Assist System is no substitute for careful and attentive driving. The Park Assist system does not detect children, pedestrians, bicyclists, animals, or objects located below the bumper or that are too close or too far from the vehicle. It is not available at speeds greater than 9 km/h (6 mph). To prevent injury, death, or vehicle damage, even with Park Assist, always check the area around the vehicle and check all mirrors before moving forward or backing.

The REAR Park Assist System can be turned on or off using the infotainment system. To view available settings from the infotainment home screen, touch Settings > Vehicle > Collision/Detection Systems.

HD REAR VISION CAMERA¹

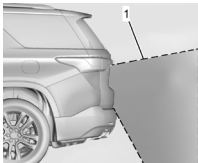

- 1. View Displayed by the Camera in Radio Screen
- 2. Corners of the Rear Bumper

Displayed images may be farther or closer than they appear. The area displayed is limited and objects that are close to either corner of the bumper or under the bumper do not display.

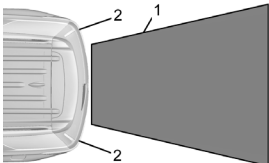





The camera(s) do not display children, pedestrians, bicyclists, crossing traffic, animals, or any other object outside of the cameras' field of view, below the bumper, or under the vehicle. Shown distances may be different from actual distances. Do not drive or park the vehicle using only these camera(s). Always check behind and around the vehicle before driving. Failure to use proper care may result in injury, death, or vehicle damage.

¹ Safety or driver assistance features are no substitute for the driver's responsibility to operate the vehicle in a safe manner. The driver should remain attentive to traffic, surroundings and road conditions at all times. Visibility, weather, and road conditions may affect feature performance. Read the vehicle's owner's manual for more important feature limitations and information.

STANDARD INTERIOR FEATURES

OnStar® (UE1)



-  Voice Command Button
-  Blue OnStar® Button
-  Emergency Button

This vehicle is equipped with a comprehensive, in-vehicle system that can connect to a live OnStar® Advisor for Emergency, Security, Navigation, Connection, and Diagnostic Services. OnStar® services may require a paid subscription. OnStar® requires the vehicle battery and electrical system, cellular service, and GPS satellite signals to be available and operating. OnStar® acts as a link to existing public emergency service providers. OnStar® may collect information about you and your vehicle, including location information. See OnStar®'s Terms and Conditions and Privacy Statement for more details including system limitations at www.OnStar.com (U.S.) or www.OnStar.ca (Canada). The OnStar® system status light is next to the OnStar® buttons. If the status light is:

- Solid Green: System is on.
- Flashing Green: On a call.
- Red: Indicates a problem.
- Off:  System is off. Press the blue OnStar® button twice to speak with an OnStar® Advisor.

Press  or call 1-888-4-ONSTAR (1-888-466-7827) to speak to an Advisor.

Press  to:

- Make a call, end a call, or answer an incoming call.
- Give OnStar® Hands-Free Calling voice commands.

NOTE: Do not activate OnStar® if you have no plans on using this feature

STANDARD MECHANICAL FEATURES

SERVICE PARTS IDENTIFICATION LABEL

SPID Label Content Now Included with Certification Label. The Service Parts Identification (SPID) label, often located in the trunk or glovebox of a vehicle, lists a vehicle's VIN, RPO codes and other information that identify the content of the vehicle. Beginning with the 2018 model year, much of this information will be available through a QR code on the Certification label.

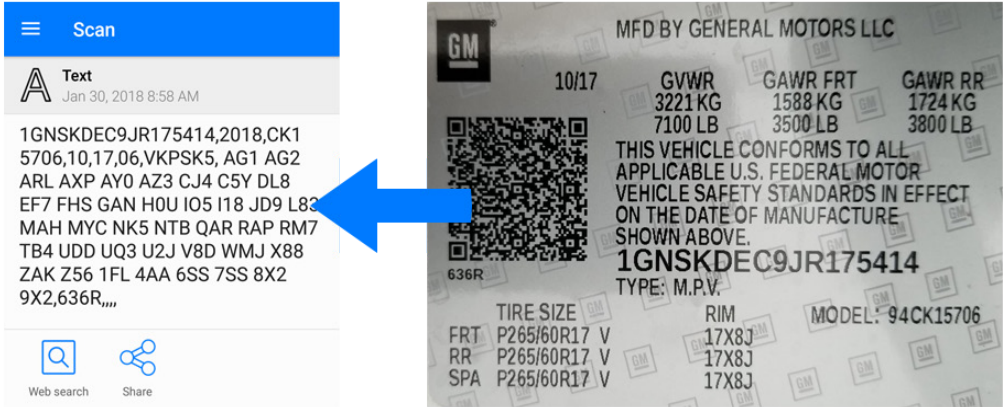

Software to read the QR code is commonly available for any Android, iPhone or Windows smartphone. Many basic applications can be downloaded for free. Tested QR code readers that are easy to use include NeoReader by NM LLC, inigma by 3GVision, QR Scanner by Honestly App, QR Droid by DroidLa and Bar-Code by PW2. GM does not recommended any particular software. Once the QR code is scanned, the vehicle information will appear in the following order: VIN, Model Year, Model, Build Month, Year, MOTORering Book, Vehicle Order Number, 3 Digit RPO Codes sorted alphanumerically, and the Paint Code (same code appears in the lower left of the QR code).

STABILITRAK CONTROL

The vehicle has a Traction Control System (TCS) and StabiliTrak/Electronic Stability Control (ESC), an electronic stability control system. These systems help limit wheel slip and assist the driver in maintaining control, especially on slippery road conditions.

TCS activates if it senses that any of the drive wheels are spinning or beginning to lose traction. When this happens, TCS applies the brakes to the spinning wheels and reduces propulsion system power to limit wheel spin.

StabiliTrak/ESC activates when the vehicle senses a difference between the intended path and the direction the vehicle is actually traveling. StabiliTrak/ESC selectively applies braking pressure to any one of the vehicle wheel brakes to assist the driver in keeping the vehicle on the intended path.

If TCS is limiting wheel spin when g is pressed, the system will not turn off until the wheels stop spinning.

If cruise control is being used and TCS or StabiliTrak/ESC begins to limit wheel spin, cruise control will disengage. Cruise control may be turned back on when road conditions allow.

Both systems come on automatically when the vehicle is started and begins to move. The systems may be heard or felt while they are operating or while performing diagnostic checks. This is normal and does not mean there is a problem with the vehicle.

It is recommended to leave both systems on for normal driving conditions, but it may be necessary to turn TCS off if the vehicle gets stuck in sand, mud, ice, or snow. See "Turning the Systems Off and On" later in this section.

Safety or driver assistance features are no substitute for the driver's responsibility to operate the vehicle in a safe manner. The driver should remain attentive to traffic, surroundings and road conditions at all times. Visibility, weather, and road conditions may affect feature performance. Read the vehicle's owner's manual for more important feature limitations and information.

STANDARD ELECTRICAL FEATURES

UNIVERSAL VEHICLE MODULE (KGU)

Provides CAN Readability of selected messages utilizing SAE J1939 formatting. This gateway module offers 10-switchable inputs and outputs, and includes a GUI (Graphical User Interface) SW available to customize the UVM to specific customer needs. Provides access to key vehicle information (CAN Serial Data) and buffer between our Cybersecure vehicle architecture and the "dirty work" side. For instructional videos refer to <https://www.gmupfitter.com/instructional-videos/>

4 Preprogrammed Commanded Features (Specified Input Voltage Range)

- Automatic Vehicle Start
 - Input request commands underhood electrical center start up for up to 8 hours or Low power condition
- Shut Down Inhibit
 - Input request prevents underhood electrical center shutdown
- Increased Engine Idle
 - Input request commands engine idle to fixed RPM value
- Snow-Plow Support
 - Input request commands deactivation of conflicting active safety features
 - Input request headlamps to full dim status

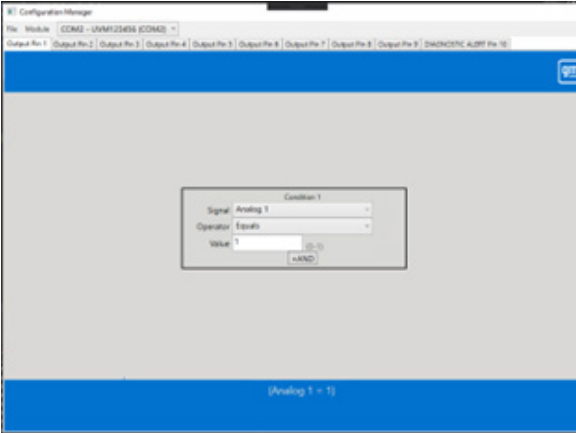

10 input/outputs configurable through GUI. Allows extensive customization of output activation criteria. Outputs are high side drive by default. Configurations can be read/write and stored for multiple vehicles. Various operating parameters available to read only. Downloadable software to configure the UVM from GM Upfitter.com

UVM Application Examples:

- Police upfits that require underhood electrical center momentary start up feature to control the HVAC climate system for K9 vehicles.
- Large Fleet customers that use telematic equipment (Geotab) to monitor mileage and idle CAN bus messages for vehicle maintenance/service schedules.



Module and user harness located right rear interior quarter panel.

STANDARD ELECTRICAL FEATURES

SURVEILLANCE MODE – SEO 5J3

The Blazer EV Police and Special Service Package has a Body Control Module (BCM) calibration which disables all automatic exterior and interior lighting. When activated, with the exterior lamp control in the auto position, the exterior and interior lighting will be disabled or dimmed to a minimum federally regulated level. For detailed technical information on activation of this feature, refer to the vehicle technical guide under the Body Builder Manuals section on www.gmupfitter.com.

RADIO MUTE FEATURE

A Radio Mute circuit (#10137) is provided to permit muting of the vehicle radio when an emergency vehicle radio is transmitting. It is the Gray/White blunt cut wire located between the front seats near the upfitter branch harness. The following customer device electrical specifications must be met to avoid damage to the vehicle Exterior Lighting Module (ELM) input circuitry:

- No inductance allowed
- Maximum Load Capacitance: 600 nano-farads.
- Maximum Closed switch contact resistance: 20 ohms
- Minimum Open switch contact resistance: 100,000 ohms

EXTERIOR LAMPS EMERGENCY FLASHING SYSTEM

Standard 6J7 provides headlamp high beam flashing and rear lamps flashing via the Exterior Lighting Module (ELM). The exterior lamps flashing is activated by customer switching of ground circuits in the upfitter harness located between the front seats (CONSOL) in the rear cargo area (CARGO). Headlamp high beam flashing is activated via connection of upfitter circuit 8863 to ground via customer switching. The headlamps and high beam indicator will flash alternately at 3 flashes per second. Rear lamps flashing is chosen by the customer to flash either Red-White alternately (Brake lamps and Reverse Lamps, grounding upfitter circuit 8865) or Red-Red alternately (Left and Right Brake Lamps, grounding upfitter circuit 8864). The rear lamps flash rate is 3 per second. Depressing the Brake pedal will override the brake lamp flashing and placing the transmission in Reverse will override the reverse lamps flashing. During daylight conditions, the Daytime Running Lamps (DRL) are automatically turned off whenever the Lamp Flashing System is activated. During night time conditions the low beam headlamps and tail lamps automatically turn on while the high beams flash. Turning on the high beam headlamps will override high beam flashing. If Option 9G8 is present the low beam head lamps and tail lamps must be manually activated. The Center Mounted Stop Lamp will operated only when the service brakes are applied.

- NOTES:
- Wiring connection or splice changes are to be removed before the vehicle is returned to civilian use.
 - For wiring diagram see Wiring Section

PROTECTED IDLE

The Protected Idle Feature allows the vehicle to remain idling but will not allow the gear selector to be shifted from Park without a valid key fob.

ACTIVATING PROTECTED IDLE

Preconditions (All preconditions must be met.)

- Vehicle is NOT in a low charge condition (Charge vehicle soon indicator is not on with yellow battery showing.)
- Vehicle is in PROPULSION state
- Vehicle is in Parked State
- Vehicle speed is less than 4 kilometers per hour
- Valid key fob is present.

Activation

Exit vehicle with key fob

Vehicle Feedback.

Upon activation of Protected Idle the Digital Information Center (DIC) will display the following:
 "Protected idle ON"
 "Park in Open Area"
 "Take Your Key"

If any of the above preconditions are not met while activating Protected Idle, DIC will display the message: *"Protected Idle Unavailable"*

DEACTIVATING PROTECTED IDLE

- Valid key fob is present
- Press brake pedal and shift out of Park **OR**
- Press the Ignition Switch with the Brake Pedal pressed.

DIC messages will turn off, indicating Protected Idle is no longer activated.

CONDITIONS UNDER WHICH THE PROTECTED IDLE WILL TURN OFF AND VEHICLE WILL TRANSITION TO OFF POWER MODE

- Brake pedal pressed without a valid key fob present **OR**
- Cruise Cancel Switch depressed without a valid key fob present **OR**
- Ignition Switch pressed without a valid key fob present **OR**
- With a valid key fob present, ignition switch is pressed and brake pedal is not pressed (the system treats this action as a customer request to turn OFF the vehicle.) **OR**
- Horn chirps occur. **OR**
- Low power condition. Horn chirps occur.

CONDITIONS UNDER WHICH THE PROTECTED IDLE WILL TURN OFF AND VEHICLE WILL TRANSITION TO RUN POWER MODE.

If the Shift Lock mechanism is defeated and shifted Out of Park while the Protected Idle is active, the vehicle will transition to the RUN power mode and Protected Idle will be deactivated and Horn chirps occur. DIC messages will turn off indicating Protected Idle is inactive.

ALWAYS PROPERLY SUPERVISE A VEHICLE WHEN PEOPLE OR ANIMALS ARE INSIDE.

OPTIONAL FEATURES



OPTIONAL FRONT AND REAR WHELEN CORNER LIGHTING

Shown with equipment from independent suppliers not covered by the GM New Vehicle Limited Warranty GM is not responsible for the safety or quality of independent supplier alterations.

OPTIONAL FEATURES



T53 REAR LIFTGATE WARNING LIGHTS



REAR CARGO AREA (SHOWN WITH FALSE CARGO FLOOR) REMOVED.

Shown with equipment from independent suppliers not covered by the GM New Vehicle Limited Warranty GM is not responsible for the safety or quality of independent supplier alterations.

OPTIONAL FEATURES

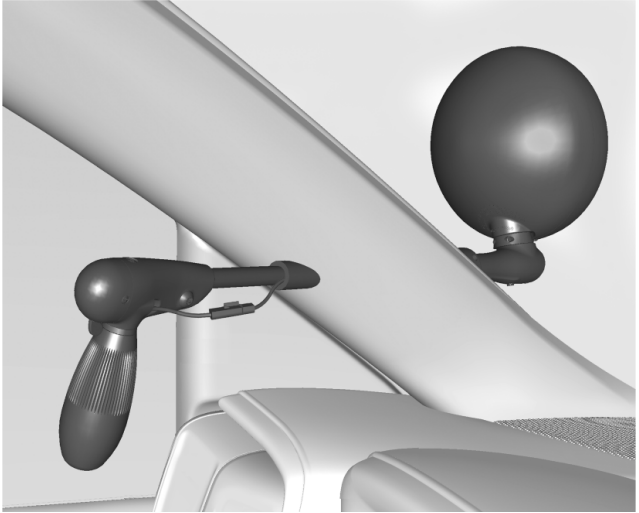
7X3	LED SPOTLAMP
	
<p>15 cm High Intensity LED spotlamp mounted to left A pillar. The lamp is protected by a 15 amp fuse in the underhood Battery Disconnect Unit (BDU). See your dealer or www.gmupfitter.com for lamp replacement procedures</p>	

6C7	AUXILIARY DOME LAMP	
		
<p>Auxiliary dome lamp is located on the headliner to the rear of the overhead console and is switched at the rear lamp base. Lamp is wired separately standard dome lamps with red and white LED bulbs.</p>		

SDE	TRAILER HITCH
	
<p>Removable 2" (Class 2.) receiver. Requires (V92) trailering provisions and (VLG) trailer hitch closeout panel.</p>	

VLG	TRAILER HITCH TRIM BEZEL
	
<p>Requires (SDE) removable trailer hitch." at bottom.</p>	

OPTIONAL FEATURES

6N5 SWITCHES - REAR WINDOW INOPERATIVE

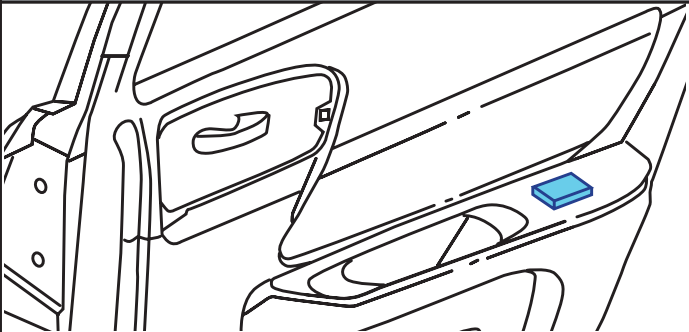

Calibration for rear windows to operate from drivers position only. Rear door window switches are inoperable. Rear door power regulators are operable only from driver position switches. Rear door window lockout switch remains illuminated in all positions when equipped with this feature.

6N6 REAR DOOR LOCKS AND HANDLES INOPERATIVE

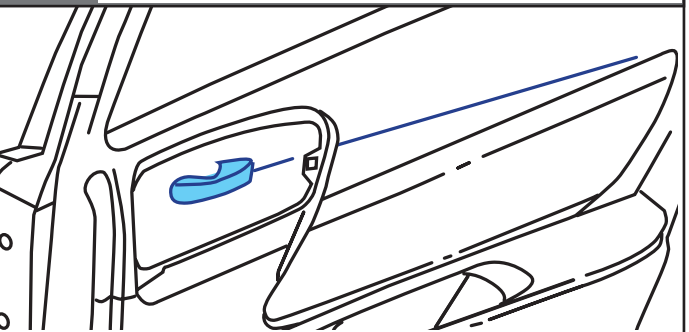

Rear door locking rods are disabled. Rear door locks are inoperable at rear doors, but operate from driver position. Inside rear door handles are disconnected. Rear doors can only be opened from the outside.

6E2 FLEET KEY & REMOTE FOB 6E8

The fleet key fob feature allows the user to program a fob to be recognized by a particular vehicle for full remote functionality (Lock/Unlock and Remote Start if equipped). Use of this remote on other fleet keyed-a-like vehicles will be limited to unlocking the driver's door by pressing the exterior door handle button and starting the vehicle once inside. The remote lock/unlock and remote start (if equipped) buttons will not function unless the operator uses the Diver Information Center (DIC) to program the newly introduced fob. Note that a vehicle is only capable of recognizing the last 8 key fobs programmed for full remote capability. Adding a 9th remote fob will bump fob #1 remote functionality until it is reprogrammed through the DIC, adding remote #1 back into the DIC will bump fob #2 remote button functionality, etc. There are no limitations to the amount of fleet keys that will be recognized to access and start the vehicle. Programming a newly introduced fleet fob through the DIC is required to use the Protected Idle feature. Requires AMF. Includes Fleet Common Key (AU7) and UTQ.

AMF PACKAGE OF FOUR UNPROGRAMMED KEYS/FOBS

AMF allows for an unlimited number of KEYS/FOBS to be paired for keyless start and keyless open, only the last 8 KEYS/FOBS learned will have the key fob buttons work for that vehicle. The programming procedure requires that two previously learned key fobs be present in the vehicle as well as the new unprogrammed fobs. Two previously paired key fobs are required for this procedure.

NOTE: If previously learned key fobs are not available, the programming of the new KEYS/FOBS must be preformed by a dealer using the Service Programming System (SPS). Key fob programming is not a warranty item and programming is conducted by the customer or at a dealer at customer expense.

Standard (BTV) remote start includes KEYS/FOBS with remote start button.

- PROGRAMING PROCEDURE:**
1. With at least 2 previously paired keys AND the new KEY/FOBS in the vehicle, Select Settings from the INFOTAINMENT HOME SCREEN
 2. Select "Vehicle" in the "Settings" screen
 3. Scroll down to " Remote Lock, Unlock, and Start"
 4. Scroll Down to select Remote Key Pairing and follow the on-screen instructions.

9G8 DRL & AHC DISABLED

Daytime Running Lamps (DRL) and Automatic Headlamp Control (AHC) are deleted. Also disables automatic interior courtesy lighting. See your dealer to restore the DRL and AHC to normal operation. With 9G8, the instrument cluster displays are dimmable only when the exterior lamp control is in the parking lamp or headlamp position.

UTQ THEFT DETERRENT DISABLE

Theft-deterrent system content is disabled. The alarm and horn become non-functional in an attempt of theft to the vehicle (recommended for vehicles utilizing 6E2 or 6E8 key codes).

WIRING

Original Equipment Alterations: Limited warranty does not cover any damage or failure resulting from modification or alteration to the vehicle's original equipment as manufactured or assembled by General Motors. Examples of the types of alterations that would not be covered include: installation or use of any non-GM part, accessory, materials, or the cutting, welding or disconnecting of the vehicle's original equipment parts and components. Any upfit device¹ connected to the open ended blunt cut circuits should be fuse protected per the "Wire Gage Table" on page 45

K219 - Lighting Control Module
 DRZ - A10 - Inside Rearview Mirror
 A11 - Radio
 E7L - Rear License Plate Lamp –Left
 E7R - Rear License Plate Lamp –Right
 E73L - Rear Fascia Signal Lamp –Left A90 Logic
 E73R - Rear Fascia Signal Lamp –Right A90 Logic
 E6 - High Mount Stop Lamp
 R44 - Radio AM Antenna Signal Filter Module – Center High Mounted Stop Lamp

KEY FOR ACRONYMS AND TERMS

CONSOL = SPACE BETWEEN FRONT SEATS
 CARGO = CARGO AREA LEFT SIDE
 IP RY CTR = IP RELAY CENTER ABOVE AND TO RIGHT OF BRAKE PEDAL
 EBCM = ELECTRIC BRAKE CONTROL MODULE
 4K PPM = 4000 PULSES PER MILE SPEED SIGNAL
 ACCY = ACCESSORY
 SURVEILLANCE = ALL AUTOMATIC LIGHTING DISABLED WHEN ACTIVATED
 PARK ENABLE = PARK RELAY ACTIVATED
 CHML = CENTER HIGH MOUNTED STOP LAMP; ON WHEN BRAKES APPLIED
 BCM = BODY CONTROL MODULE
 ELM = EXTERIOR LIGHT MODULE
 WDO = WINDOW
 SYNC = SYNCHRONIZED

WIRING

GM Option Code	Wire Gage [mm^2]	Console Connector Terminal	Cargo Connector Terminal	Wire Color	Circuit Name /Circuit #
6J3	0.8	13533797 Terminal 2	13533797 Terminal 2	Brown	8855-Police Front Grille Light 1 Power
6J3	0.8	13533797 Terminal 3	13533797 x 1 Terminal 3	Brown/Blue	8856-Police Front Grille Light 2 Power
6J3	0.8	13533797 Terminal 4	13533797 x 1 Terminal 4	Black/Brown	8857-Police Front Grille Light Return
6J3	0.8	13533797 x 1 Terminal 5	13533797 x 1 Terminal 5	White	8858-Police Front Grille Light Synchronization
6J3	0.8	13533797 x 1 Terminal 6	13533797 x 1 Terminal 6	Brown/Yellow	8859-Police Front Grille Light Steady Burn Activation
6J3	0.8	13533797 x 1 Terminal 7	13533797 x 1 Terminal 7	White/Black	8860-Police Front Grille Spare 1
6J3	1.5	13533797 x 1 Terminal 36	13533797 x 1 Terminal 36	Green/White	8861-Police Front Grille Speaker +
6J3	1.5	13533797 x 1 Terminal 37	13533797 x 1 Terminal 37	Blue/White	8862-Police Front Grille Speaker -
6J7	0.35	13533797 x 1 Terminal 8	13533797 x 1 Terminal 8	Green	8863-Police High Beam Alternate Flash Enable.
5L0	0.35	13533797 x 1 Terminal 9	13533797 x 1 Terminal 9	Blue/Green	8864-Police Tail Lamp Red/Red Alternate Flash Enable.
5J9	0.35	13533797 x 1 Terminal 10	13533797 x 1 Terminal 10	Gray/Green	8865-Police Tail Lamp Red/White Alternate Flash Enable.
T53	0.8	X1 - 13533797 Terminal 11	X1 - 13533797 Terminal 11	White	8867-Police Liftgate Strobe Synch
T53	0.35	X1 - 13533797 Terminal 12	X1 - 13533797 Terminal 12	Violet/Yellow	8868-Police Liftgate Strobe Enable 1
T66 left front	0.75	None	X1 - 13544146 - Terminal 1	Violet	8870-Police Left Mirror Light Power
T66 left front	0.75	None	X1 - 13544146 - Terminal 2	Black/Violet	8871-Police Left Mirror Light Return
T66 left front	0.75	None	X1 - 13544146 - Terminal 3	White/Violet	8872-Police Left Mirror Light Synchronization
T66 left front	0.75	None	X1 - 13544146 - Terminal 4	Blue/Violet	8873-Police Left Mirror Light Steady Burn
T66 left front	0.75	None	X1 - 13544146 - Terminal 5	Yellow/Violet	8874-Police Left Mirror Light Flash Enable
T66 left rear	0.75	None	X1 - 13544146 - Terminal 6	Green	8875-Police Left Rear Window Light Power
T66 left rear	0.75	None	X1 - 13544146 - Terminal 7	Black/Green	8876-Police Left Rear Window Light Return
T66 left rear	0.75	None	X1 - 13544146 - Terminal 8	White/Green	8877-Police Left Rear Window Light Synchronization
T66 left rear	0.75	None	X1 - 13544146 - Terminal 9	Blue/Green	8878-Police Right Rear Window Light Steady Burn
T66 left rear	0.75	None	X1 - 13544146 - Terminal 10	Yellow/Green	8879-Police Right Rear Window Light Flash Enable
T66 right front	0.75	None	X1 - 13544146 - Terminal 11	Gray	8880-Police Right Mirror Light Power
T66 right front	0.75	None	X1 - 13544146 - Terminal 12	Black/Gray	8881-Police Right Mirror Light Return
T66 right front	0.75	None	X1 - 13544146 - Terminal 13	White/Gray	8882-Police Right Mirror Light Synchronization
T66 right front	0.75	None	X1 - 13544146 - Terminal 14	Blue/Gray	8883-Police Right Mirror Light Steady Burn
T66 right front	0.75	None	X1 - 13544146 - Terminal 15	Yellow/Gray	8884-Police Right Mirror Light Flash Enable
T66 right rear	0.75	None	X1 - 13544146 - Terminal 16	Brown	8885-Police Right Rear Window Light Power
T66 right rear	0.75	None	X1 - 13544146 - Terminal 17	Black/Brown	8886-Police Right Rear Window Light Return
T66 right rear	0.75	None	X1 - 13544146 - Terminal 18	White/Brown	8887-Police Right Rear Window Light Synchronization
T66 right rear	0.75	None	X1 - 13544146 - Terminal 19	Blue/Brown	8888-Police Right Rear Window Light Steady Burn
T66 right rear	0.75	None	X1 - 13544146 - Terminal 20	Yellow/Brown	8889-Police Right Rear Window Light Flash Enable
UT7 / 6J1	5	13533168 x1 for pwr and grd term 2	NA	Black	7150-Ground (71) Police
6J1, Police Provisions (Rear)	5	13533168		RD/GN	742-Primary Fused Battery Positive Voltage (7)
6J8/9/G/E	1	None	X1 - 13533797 Terminal 29	Blue	8890-Police Front Corner Light Power
6J8/9/G/E	1	None	X1 - 13533797 Terminal 31	Blue/White	8891-Police Corner Strobe Synchronization
6J8/9/G/E	1	None	X1 - 13533797 Terminal 38	Green	8892-Police Rear Corner Light Power
6J8/9/G/E	1	None	X1 - 13533797 Terminal 34	Violet	8893-Police Front Corner Strobe Power
6J8/9/G/E	1	None	X1 - 13533797 Terminal 30	BN/WH	8915
6J8/9/G/E	1	None	X1 - 13533797 Terminal 35	Yellow	8894-Police Rear Corner Strobe Power
WX7	0.5	NA	NA	See K2 Tahoe wire colors	201
WX7	0.5	NA	NA	See K2 Tahoe wire colors	118
WX7	0.5	NA	NA	See K2 Tahoe wire colors	200
WX7	0.5	NA	NA	See K2 Tahoe wire colors	117
WX7	0.5	NA	NA	See K2 Tahoe wire colors	199
WX7	0.5	NA	NA	See K2 Tahoe wire colors	116
WX7	0.5	NA	NA	See K2 Tahoe wire colors	46
WX7	0.5	NA	NA	See K2 Tahoe wire colors	115
T53	0.8	NA	NA	Violet	8866-Police Liftgate Strobe Power
T53	0.8	NA	NA	Black	7650-Ground (76) Police
T53	0.35	NA	NA	Violet/Green	8869-Police Liftgate Strobe Rear On OFF
7X3	0.75			RD/GN	10240-Secondary Fused Battery Positive Voltage (102) Police
7X3	0.75			Black	7750-Ground (77) Police
7X3	0.75			RD/GY	10340-Secondary Fused Battery Positive Voltage (103) Police
7X3	0.75			Black	7850-Ground (78) Police
6C7 Aux. dome lamp	0.75			D/BU	10140-Secondary Fused Battery Positive Voltage (101) Police
6C7 Aux. dome lamp	0.75			Black	7550-Ground (75) Police
6J4	0.35			BN/WH	Circuit 28

WIRING

GM Option Code	Wire Gage [mm ²]	Console Connector Terminal	Cargo Connector Terminal	Wire Color	Circuit Name /Circuit #
Police Provisions, console area	0.5	X1 - 13533797 Terminal 28	Na	Blue/Yellow	8895-Police Relay 1 Control
Police Provisions, console area	1	X1 13533797 Terminal 32	NA	RD/GN	8911-Police Select Supply Voltage 1
Police Provisions, console area	0.5	X1 - 13533797 Terminal 29	NA	Green/Yellow	8896-Police Relay 2 Control
Police Provisions, console area	1	13533797 Terminal 33	NA	RD/GY	8912-Police Select Supply Voltage 2
Police Provisions, console area	10	NA	13533168 x1 for pwr and grd	RD/VT	842-Primary Fused Battery Positive Voltage (8)
6J1 , Police Provisions, console area	10	NA	13533168 x1 for pwr and grd	Black	7350-Ground (73) Police
6J1 , Police Provisions, console area	0.5	X1 - 13533797 Terminal 13	X1 - 13533797 Terminal 13		Circuit 817
6J1 , Police Provisions, console area	0.5	X1 - 13533797 Terminal 14	X1 - 13533797 Terminal 14		Circuit 2801
6J1 , Police Provisions, console area	0.5	X1 - 13533797 Terminal 15	X1 - 13533797 Terminal 15		4939-Run/Crank Ignition 1 Voltage (49)
6J1 , Police Provisions, console area	0.35	X1 - 13533797 Terminal 16	X1 - 13533797 Terminal 16		Circuit 8917
6J1 , Police Provisions, console area	0.35	X1 - 13533797 Terminal 18	X1 - 13533797 Terminal 18		Circuit 6821
6J1 , Police Provisions, console area	0.5	X1 - 13533797 Terminal 19	X1 - 13533797 Terminal 19		Circuit 820
6J1 , Police Provisions, console area	0.5	X1 - 13533797 Terminal 20	X1 - 13533797 Terminal 20		Circuit 5813
6J1 , Police Provisions (Rear) I	0.5	NA	X1 - 13533797 Terminal 21	Gray/Yellow	8897-Police Relay 3 Contro
8907-Police Select Fuse Supply Voltage 3	2.5	NA	X1 13533797 Terminal 1	RD/WH	8913- Select fuse supply voltage
8898 6J1 , Police Provisions (Rear)	0.5	NA	X1 - 13533797 Terminal 32,	Violet/Yellow	8898-Police Relay 4 Control
8914-Police Select Fuse Supply Voltage 4	2.5	NA	X1 13533797 Terminal 17	RD/YE	8914- Select fuse supply voltage
Steering wheel switches	0.35	X1 - 13533797 Terminal 22	X1 - 13533797 Terminal 22	BN/GY	8021-Police Microphone Enable
Steering wheel switches	0.35	X1 - 13533797 Terminal 23	X1 - 13533797 Terminal 23	Grey/Violet	8022-Police Roof Lamp Control
Radio mic.	0.5	X1 - 13533797 Terminal 24	X1 - 13533797 Terminal 24	Black	7450-Ground (74) Police
Radio mic.	0.5	X1 - 13533797 Terminal 25	X1 - 13533797 Terminal 25	Blue/White	8899-Police Microphone Data
Radio mic.	0.5	X1 - 13533797 Terminal 26	X1 - 13533797 Terminal 26	Blue/Violet	8900-Police Microphone Input
Dimmer function for Instrument Panel	0.8	X1 - 13533797 Terminal 27	X1 - 13533797 Terminal 27	YE	Circuit 6817

WIRING

XP2 UPFITTER WIRING HARNESS

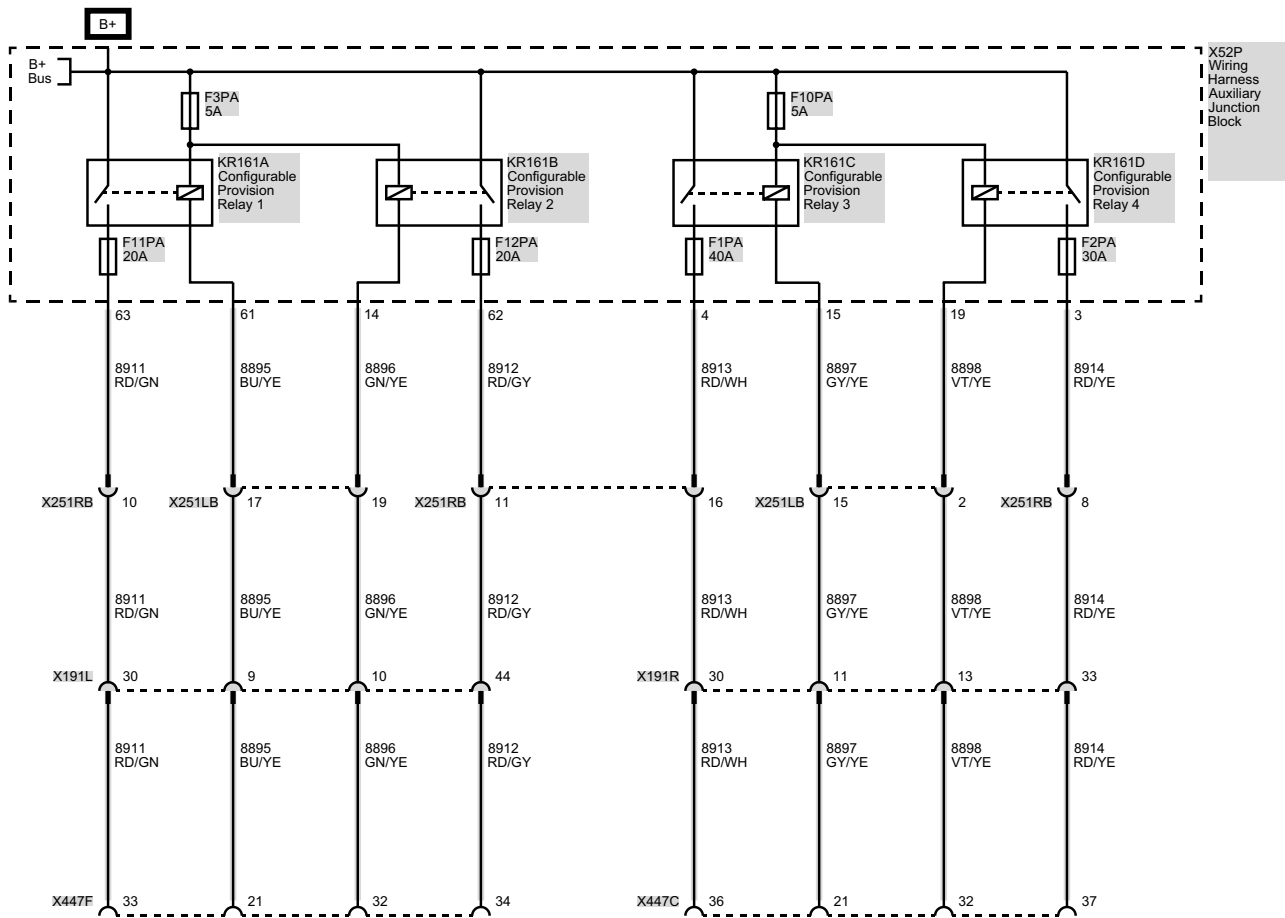

CONNECTOR BETWEEN FRONT SEATS

CONNECTOR IN REAR CARGO AREA



Located under console

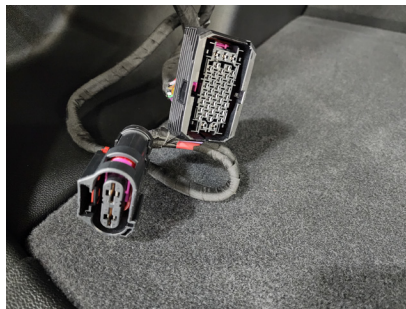

Located behind left rear cargo trim

WIRING

MAIN FUSE POWER, ACCESSORY RUN, VEHICLE SPEED

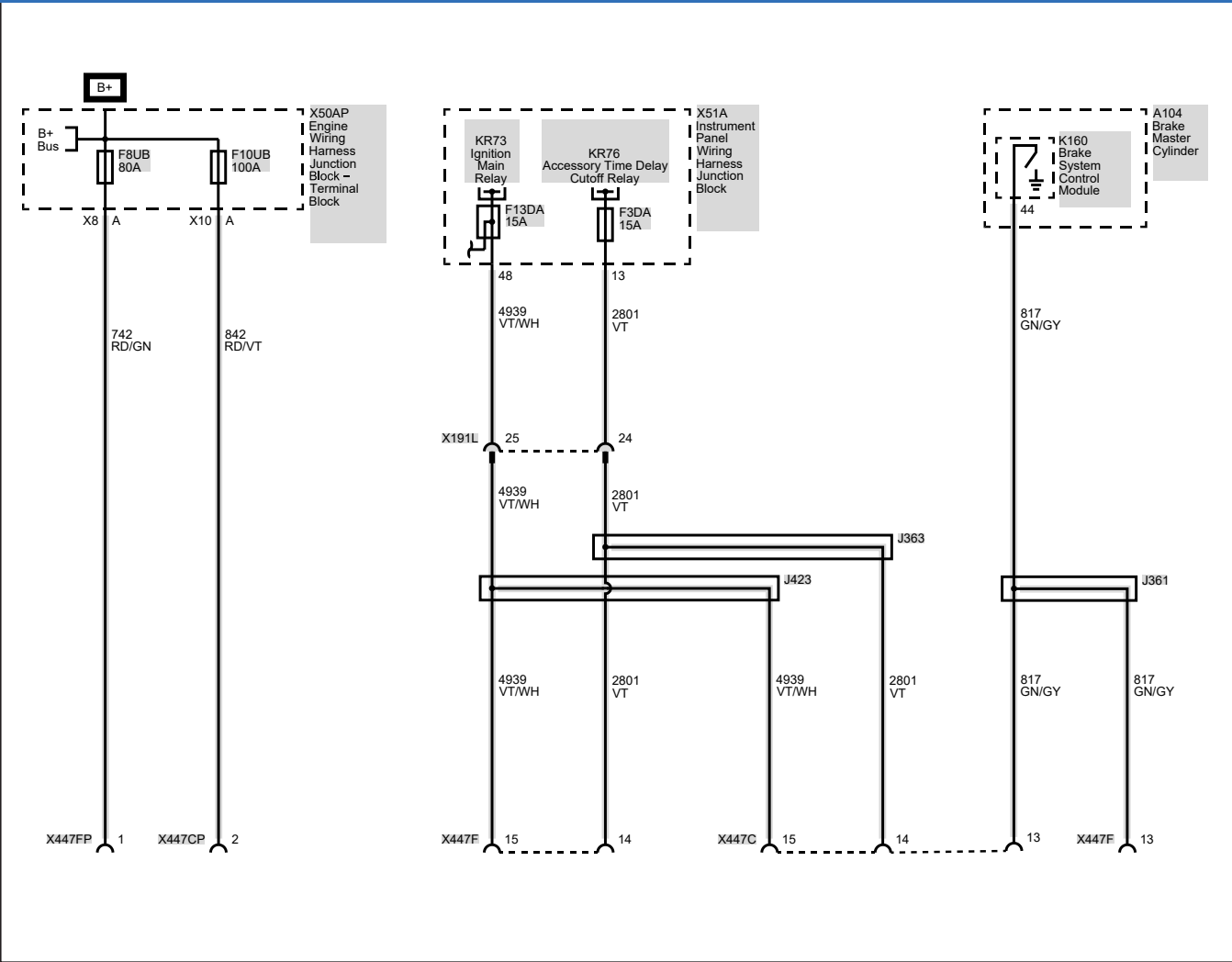

WIRING

KGU UNIVERSAL VEHICLE MODULE

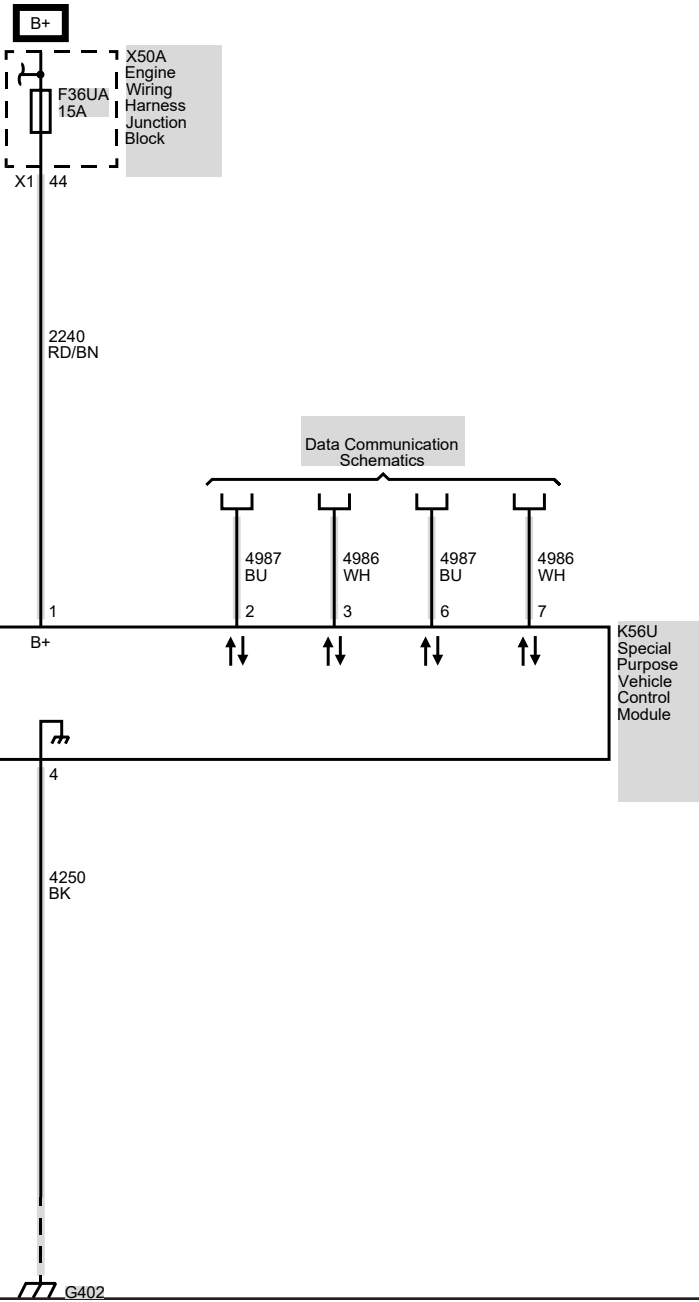

For instructional videos refer to <https://www.gmupfitter.com/instructional-videos/>

WIRING

REPURPOSED STEERING WHEEL SWITCHES

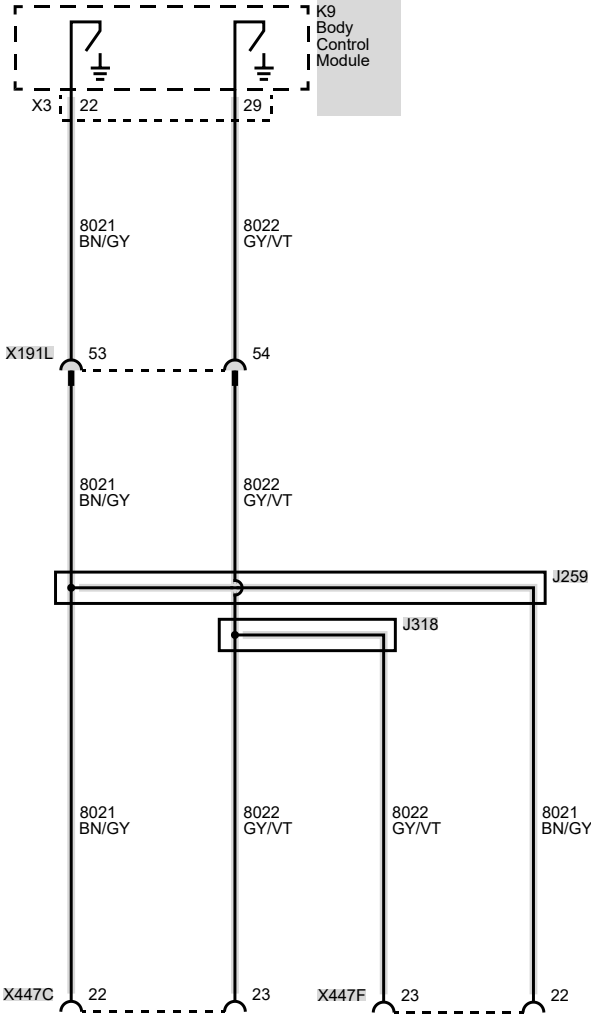

WIRING

BCM SIGNAL PROVISIONS

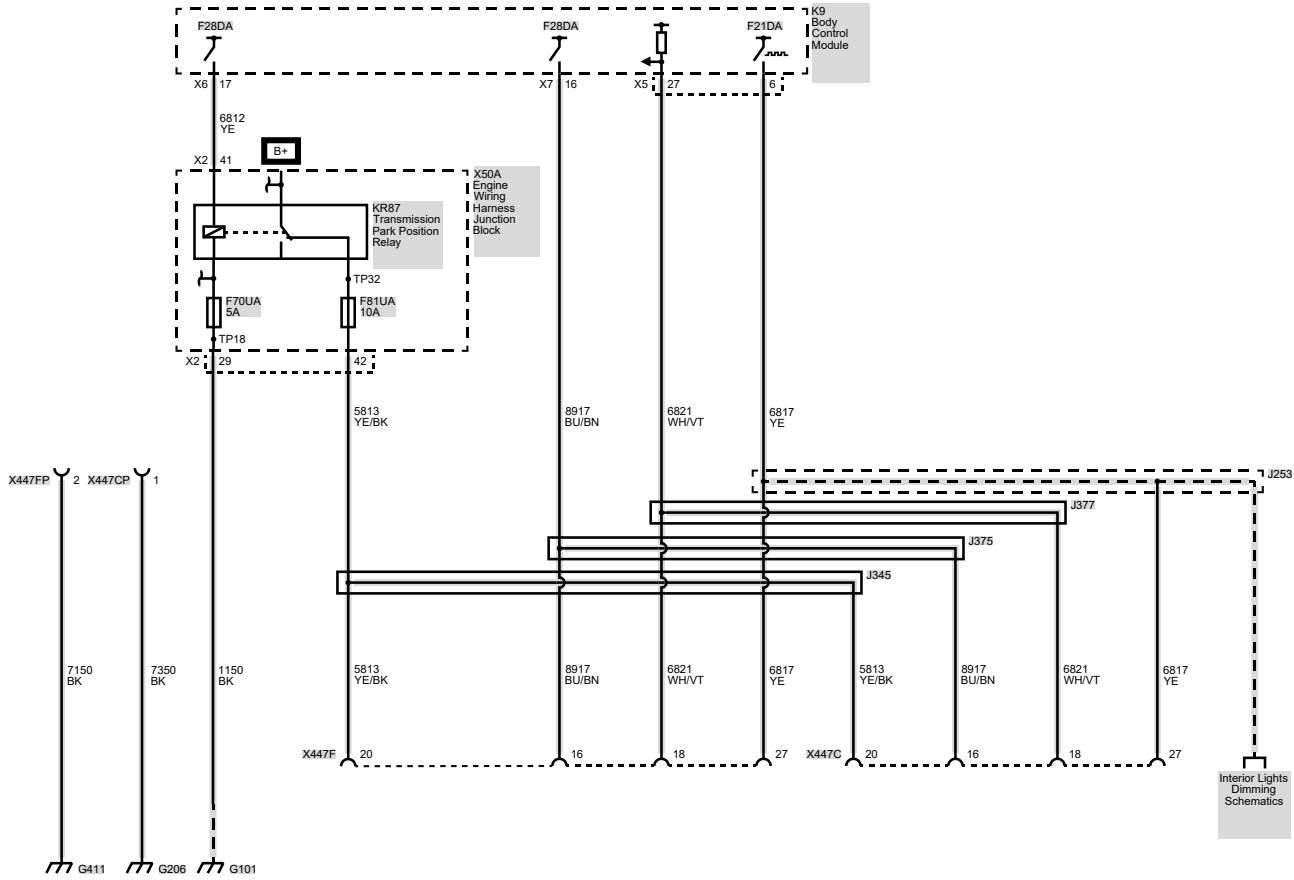

WIRING

RADIO MICROPHONE PROVISIONS

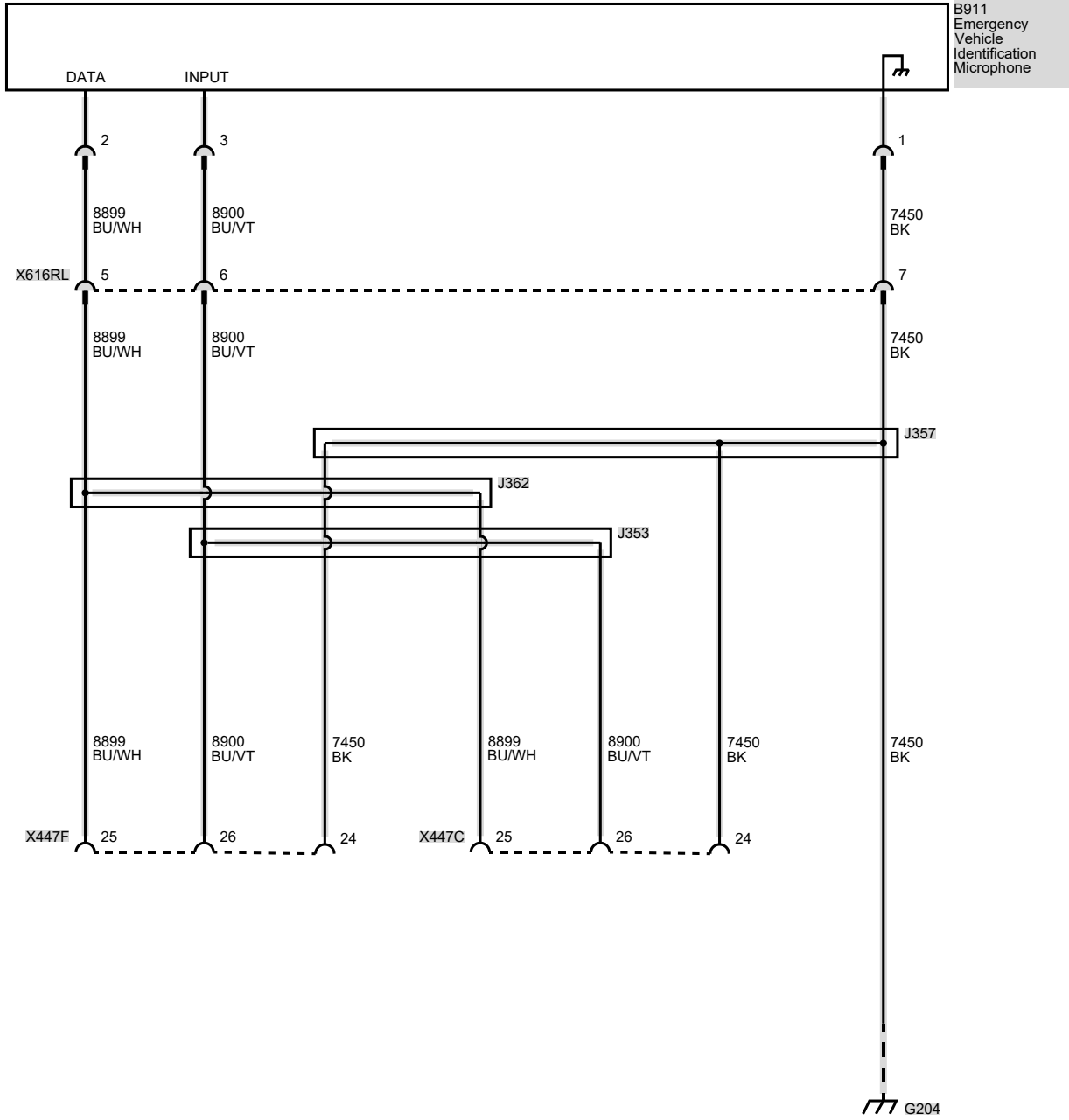

WIRING

6JE / 6JG / 6J8 / 6J9 EMERGENCY VEHICLE CORNER STROBE LIGHTS FRONT

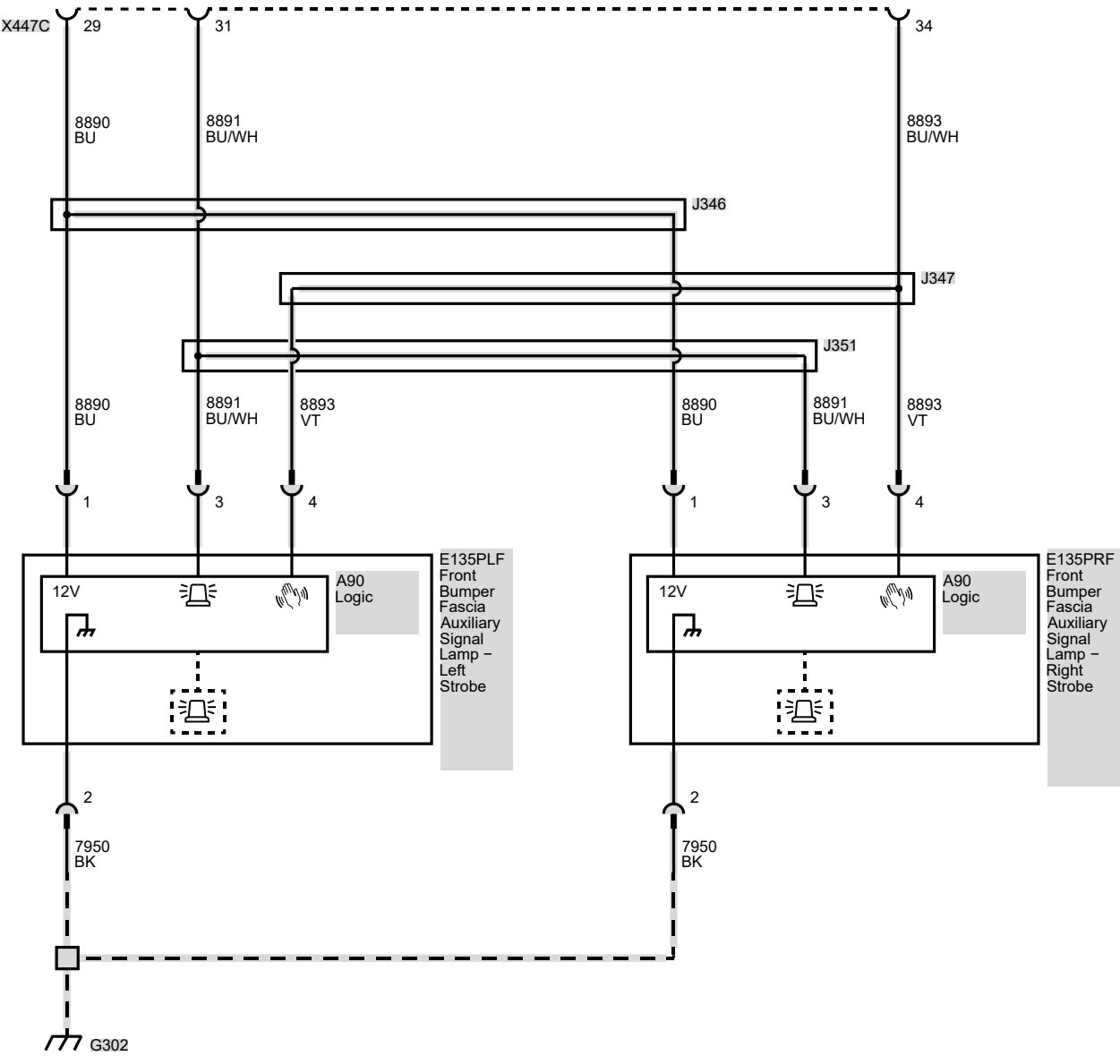

WIRING

6JE / 6JG / 6J8 / 6J9
EMERGENCY VEHICLE CORNER STROBE LIGHTS REAR

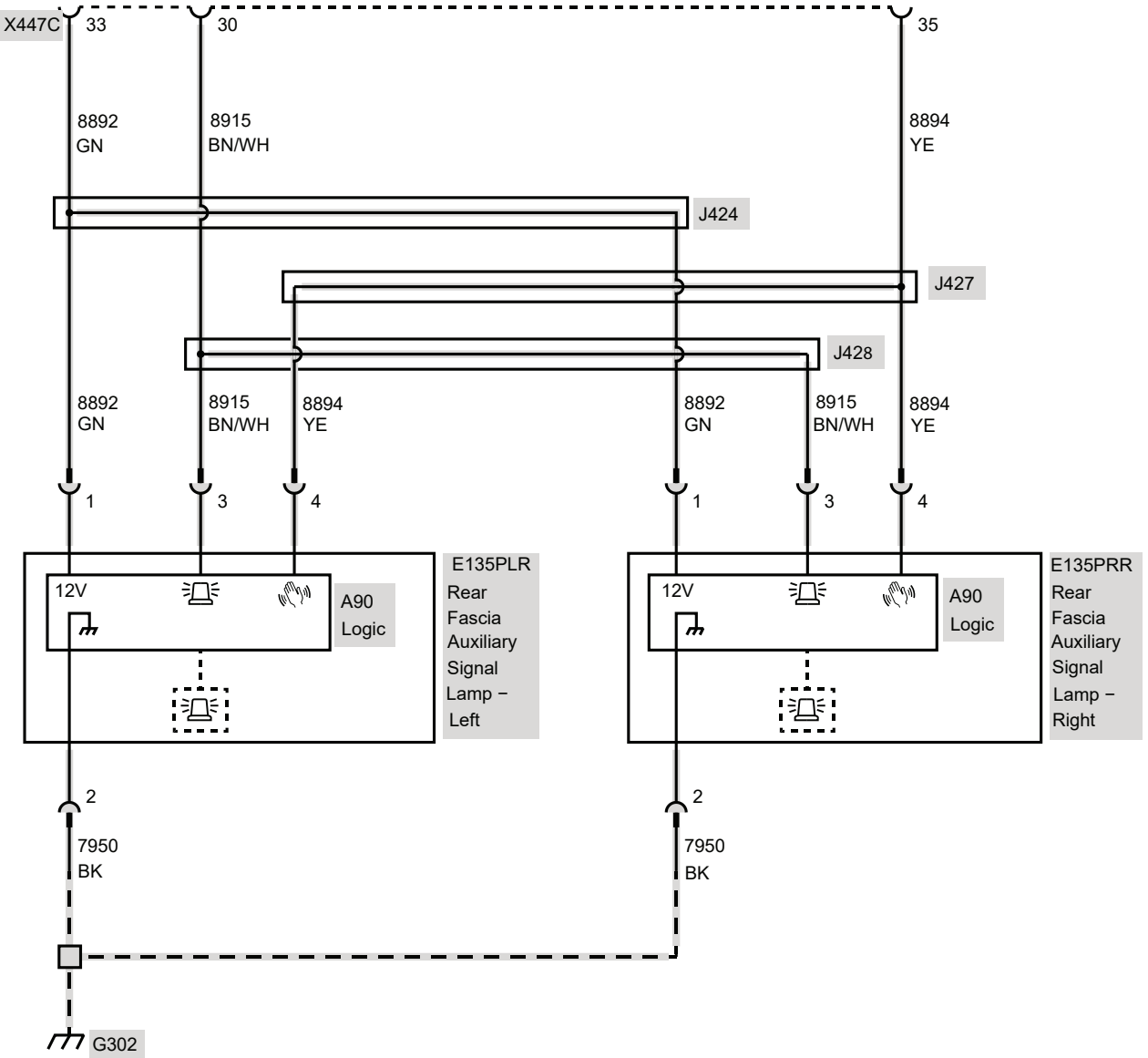

OPTIONAL WIRING

6J3 - GRILLE LAMPS AND SIREN SPEAKER PROVISIONS

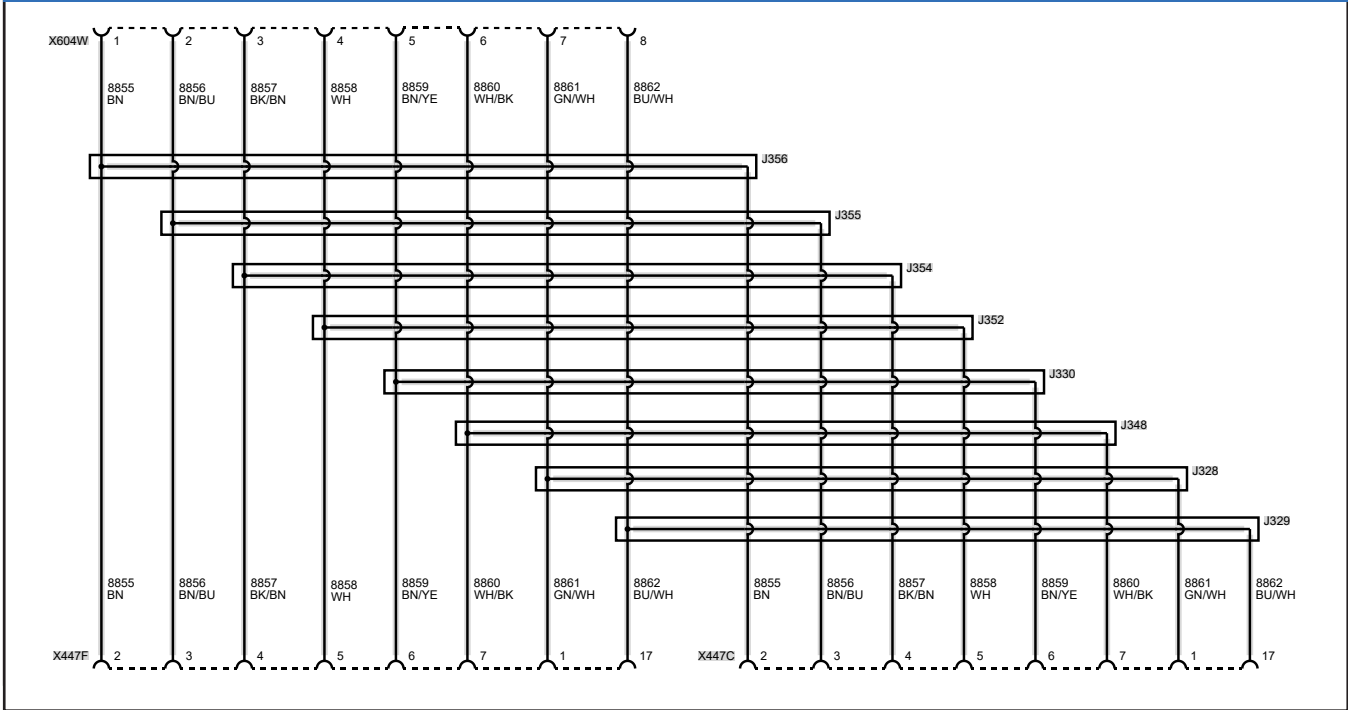

FRONT MIRROR AND REAR WINDOW FLASHER PROVISIONS

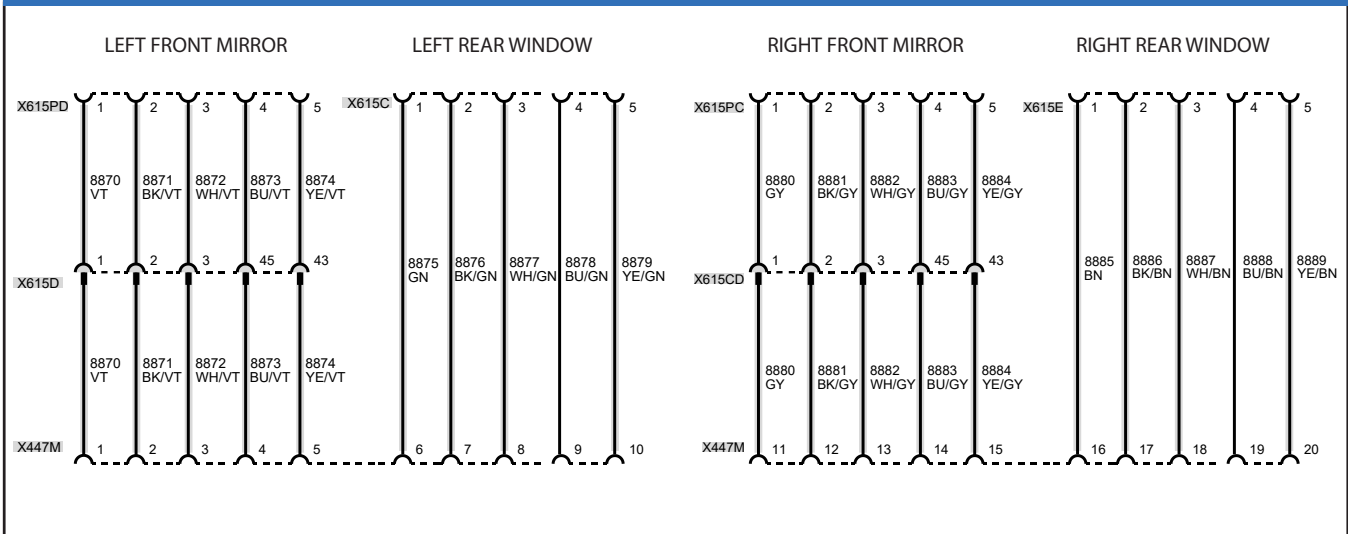

WIRING

6J7, 5LO & 5J9 - HEADLAMPS AND REAR LAMPS FLASHING SYSTEM PROVISIONS

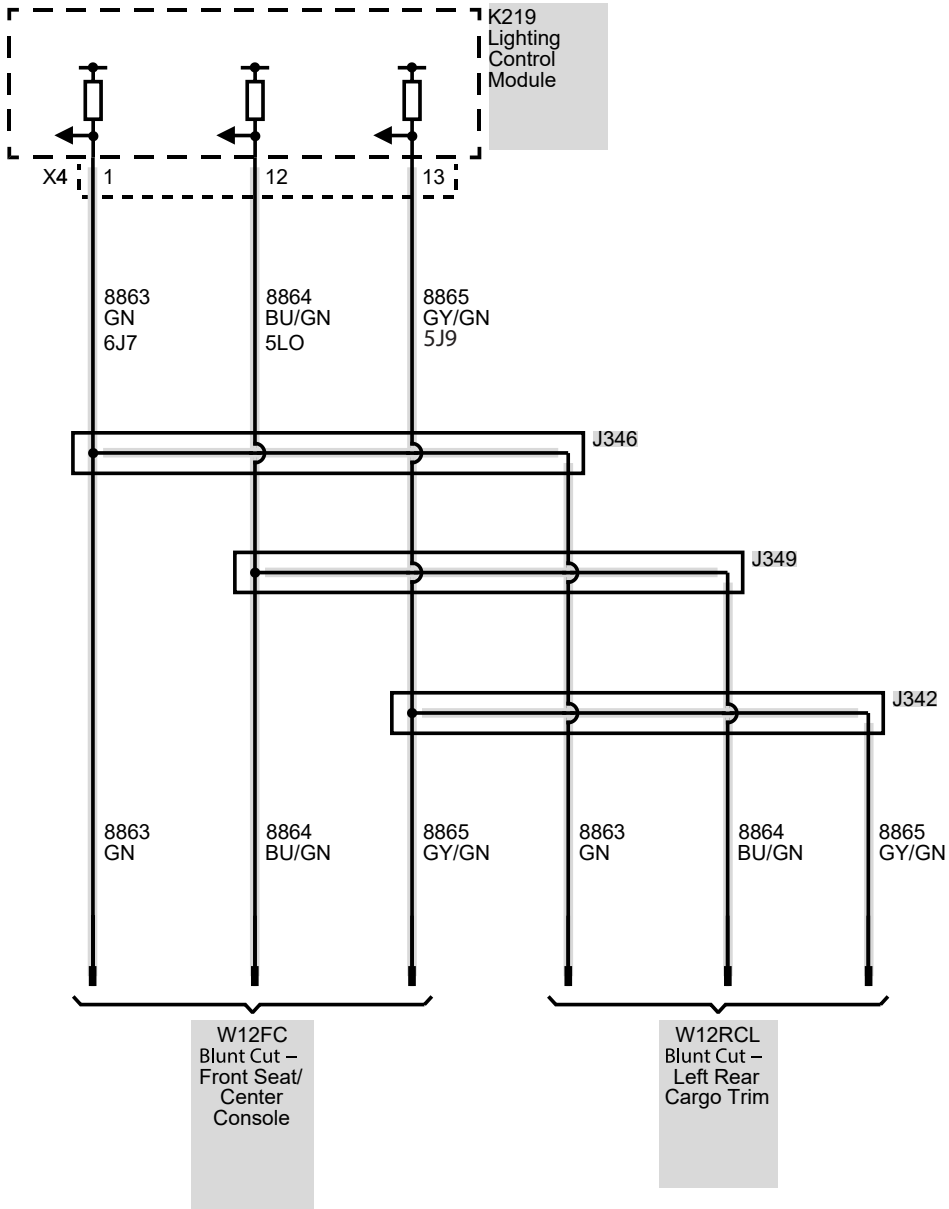

OPTIONAL WIRING

WX7 FRONT DOOR SPEAKERS PROVISIONS

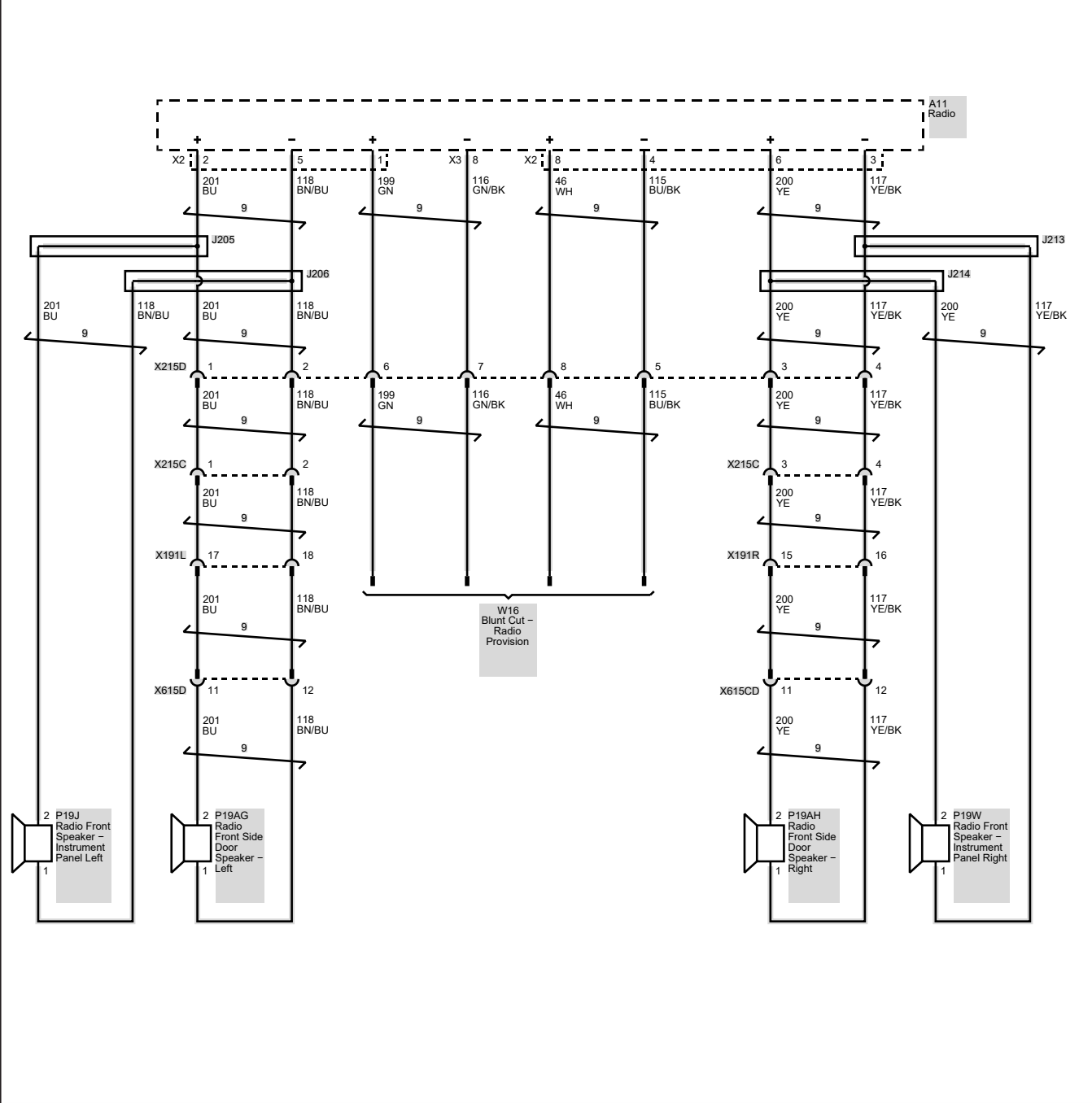

OPTIONAL WIRING

6J4 - HORN AND SIREN CONTROL PROVISION

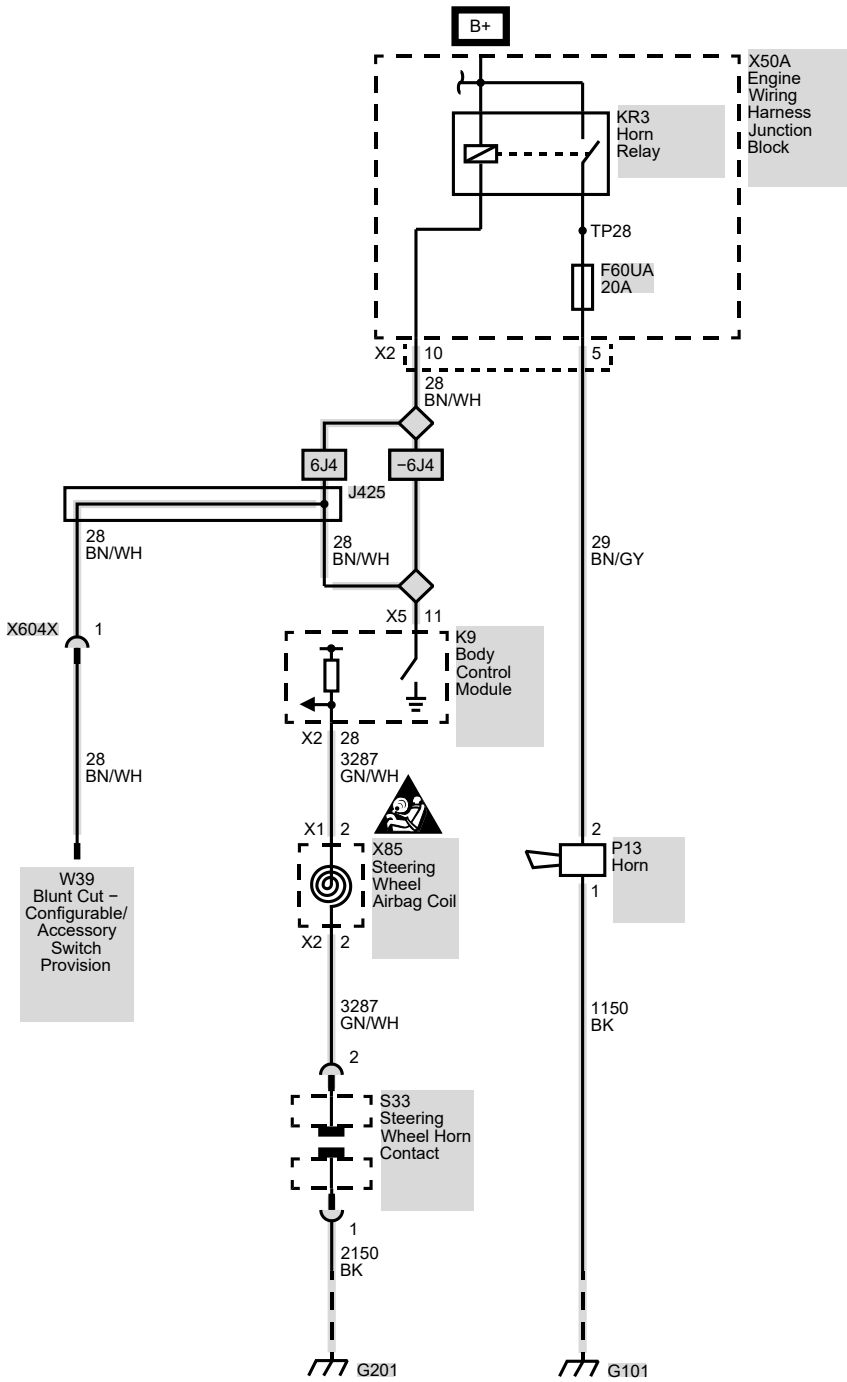

OPTIONAL WIRING

T53 - LIFTGATE WARNING LAMPS & 6C7 AUXILIARY DOME LAMP

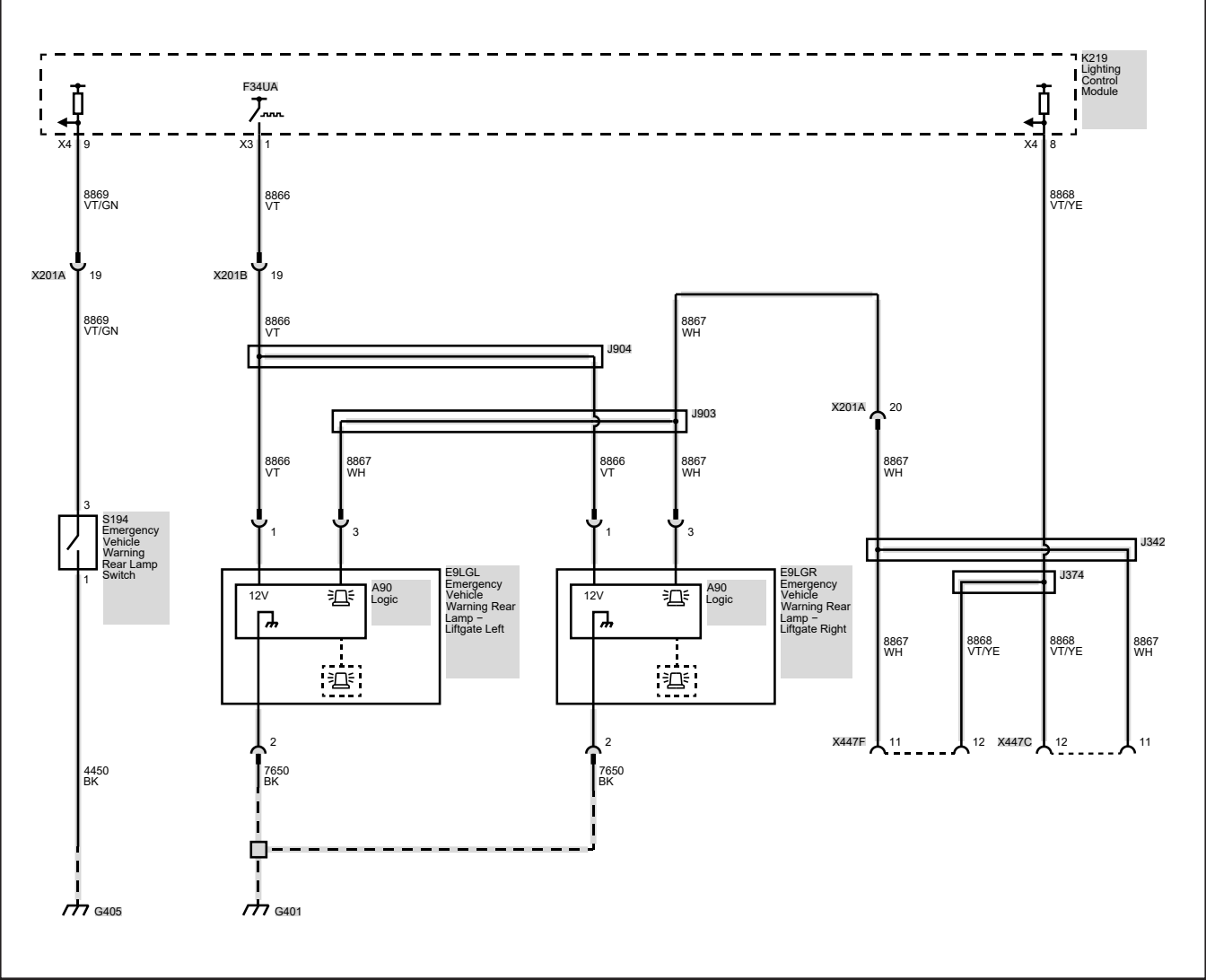

OPTIONAL WIRING



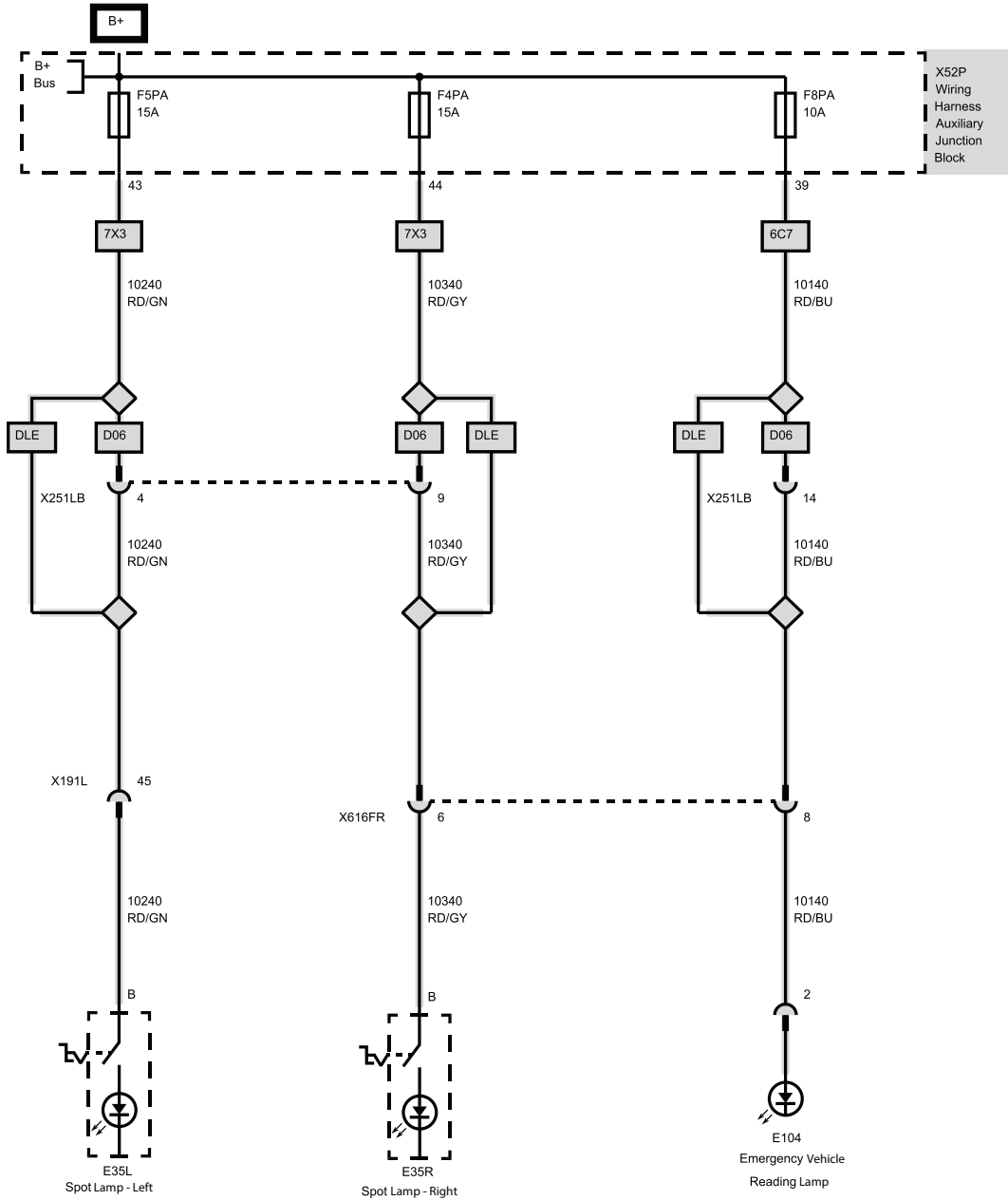



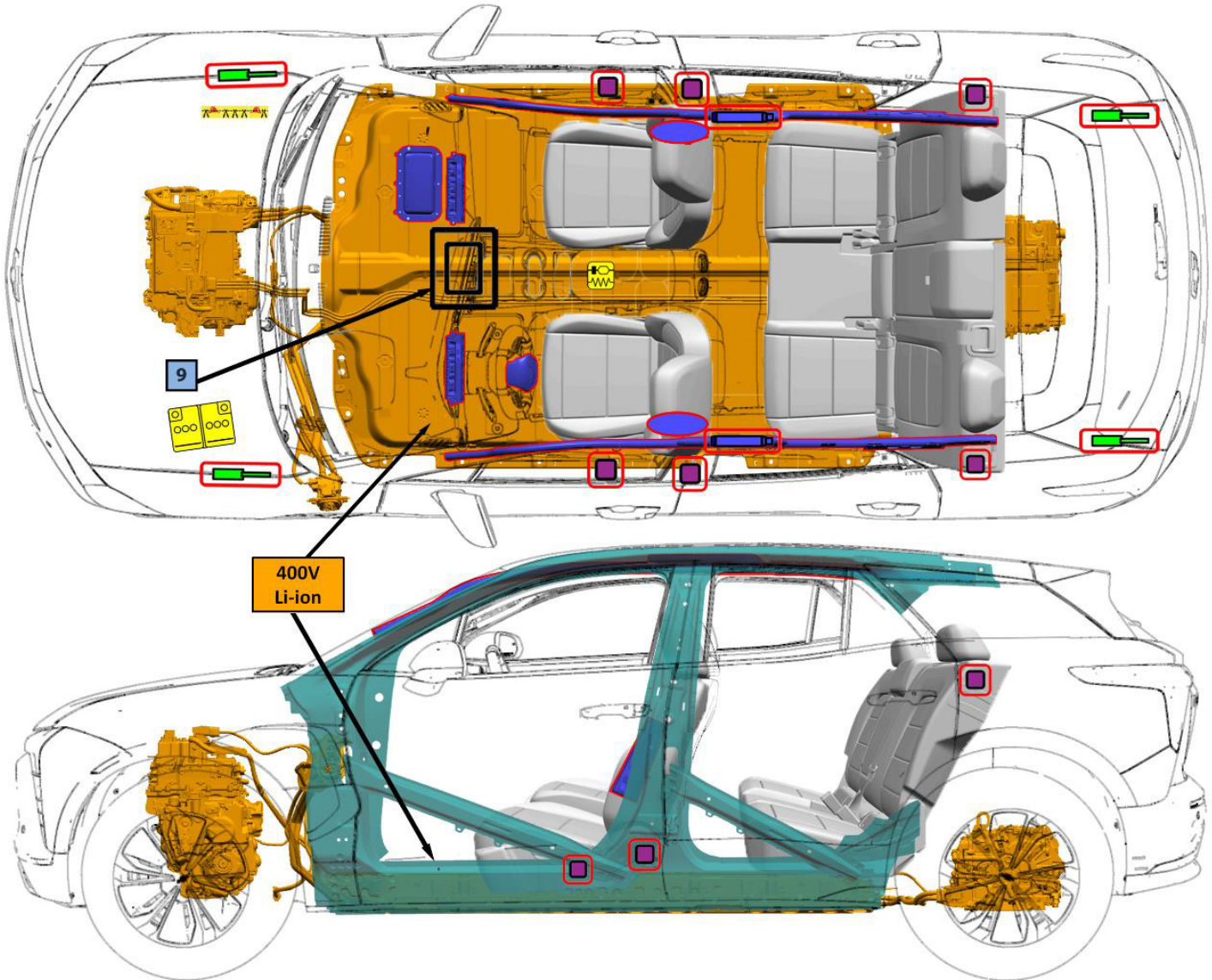



7X3 LED SPOT LAMPS & 6C7 AUXILIARY DOME LAMP



NO DRILL / NO CUT ZONES



WARNING - DO NOT CUT ANY ORANGE COLORED HIGH VOLTAGE CABLES

LEDGEND									
	Airbag		Stored gas inflator		Seat belt pretensioner		SRS control unit		Gas strut/ Preloaded spring
	High strength zone		Zone requiring special attention		Battery low voltage		High voltage battery pack		High voltage power cable component
	Cable Cut Location								

AIRBAGS

FRONTAL AIRBAGS

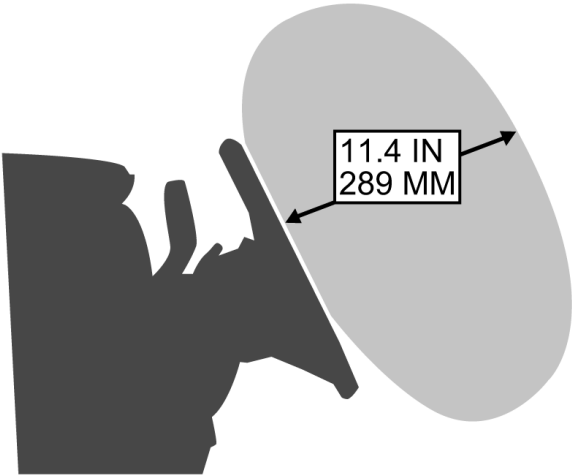

STEERING DRIVER AIRBAG
VIEW FROM DRIVER SIDE

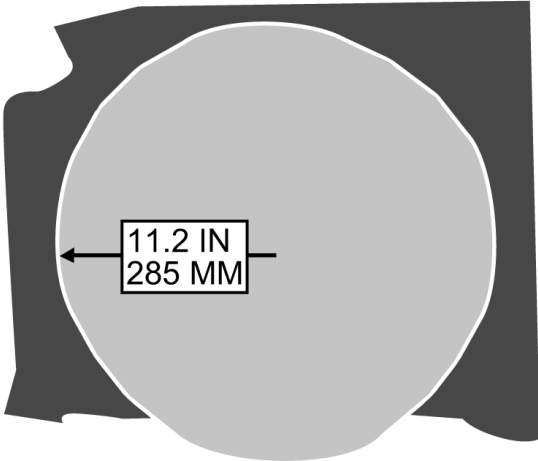

STEERING WHEEL DRIVER AIRBAG
VIEW FROM DRIVER SIDE

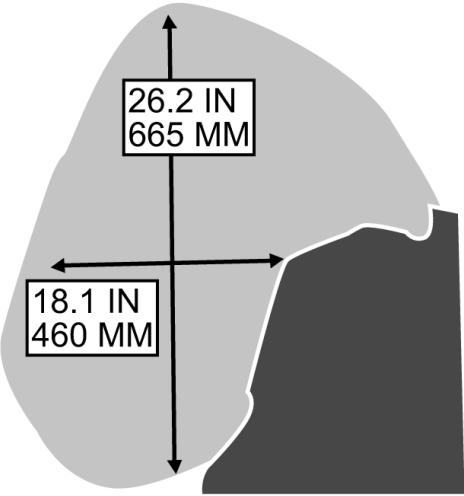

STEERING WHEEL DRIVER AIRBAG
VIEW FROM PASSENGER SIDE

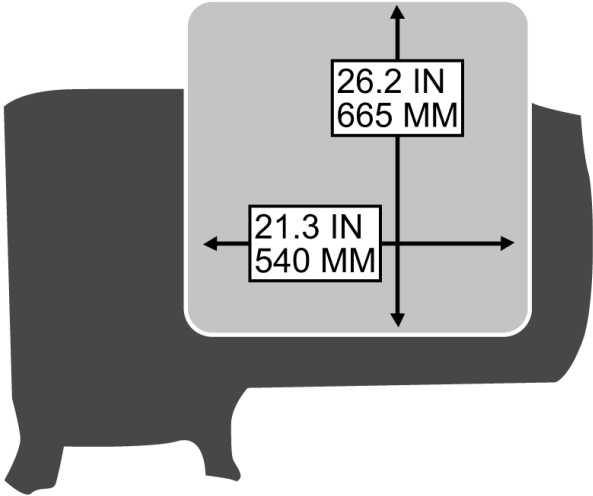

FRONT OUTBOARD PASSENGER AIRBAG
VIEW FROM PASSENGER SIDE

Sitting too close to an airbag when it deploys can increase the risk of serious injury or death. Always properly wear your seat belt. See Owner's Manual for more information.

AIRBAGS

HEAD-CURTAIN AND FRONT SIDE IMPACT AIRBAGS

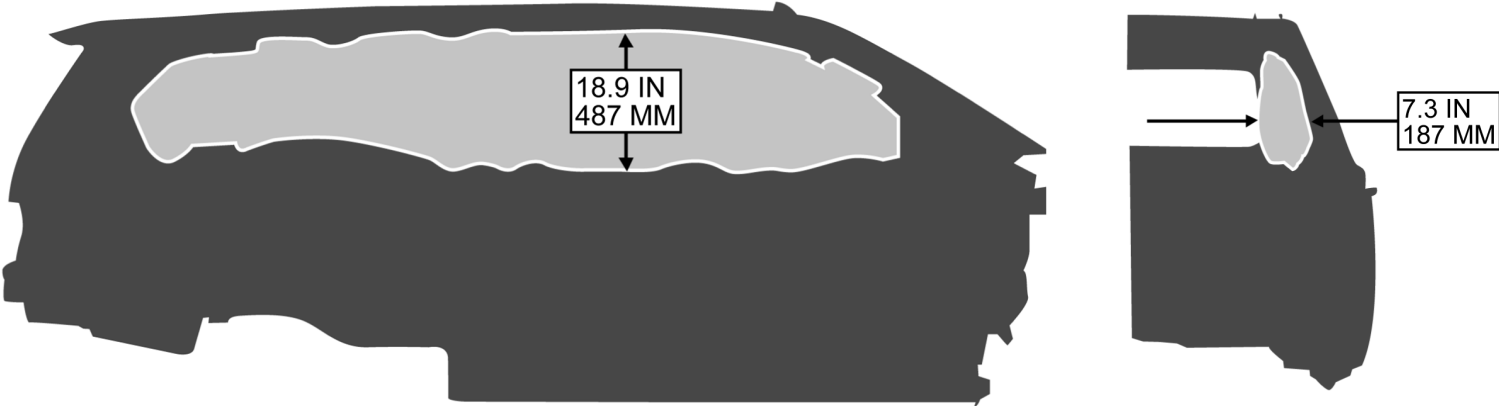

HEAD CURTAIN AIRBAG

DRIVER SIDE SHOWN - PASSENGER SIDE SIMILAR

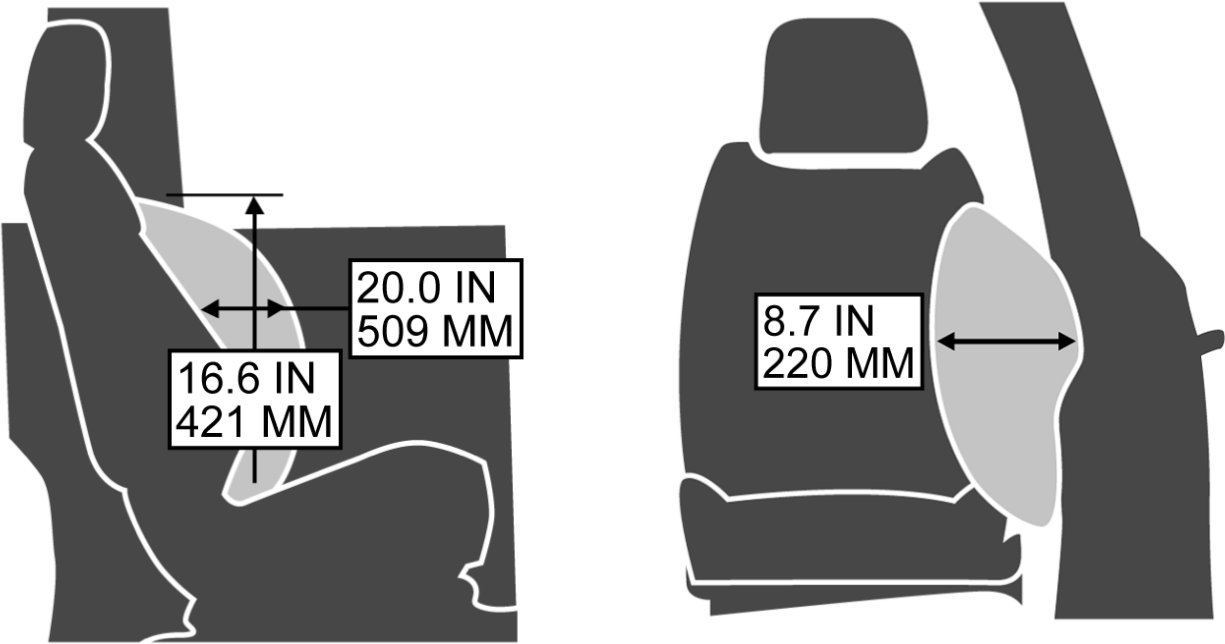

FRONT SEAT SIDE IMPACT AIRBAG

DRIVER SEAT SHOWN - FRONT OUTBOARD PASSENGER SIMILAR

Sitting too close to an airbag when it deploys can increase the risk of serious injury or death. Always properly wear your seat belt. See Owner's Manual for more information.

AIRBAGS

HEAD-CURTAIN AND FRONT SIDE IMPACT AIRBAGS

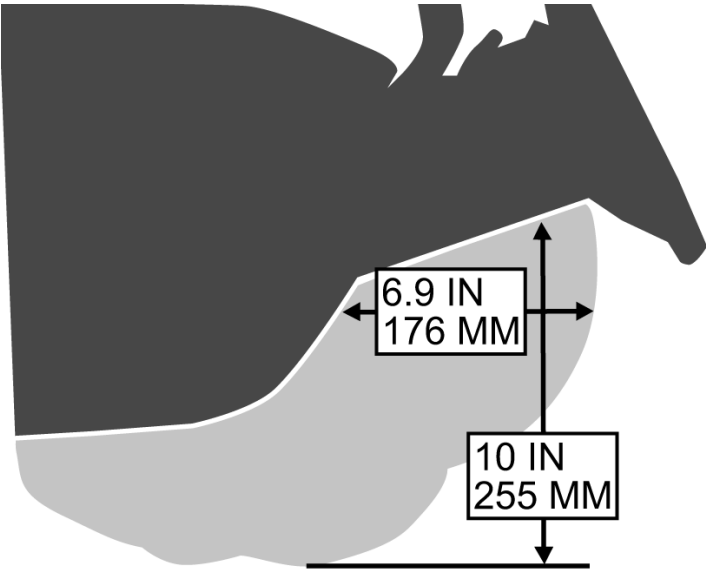

KNEE AIRBAG
SIDE VIEW FROM DRIVER SIDE

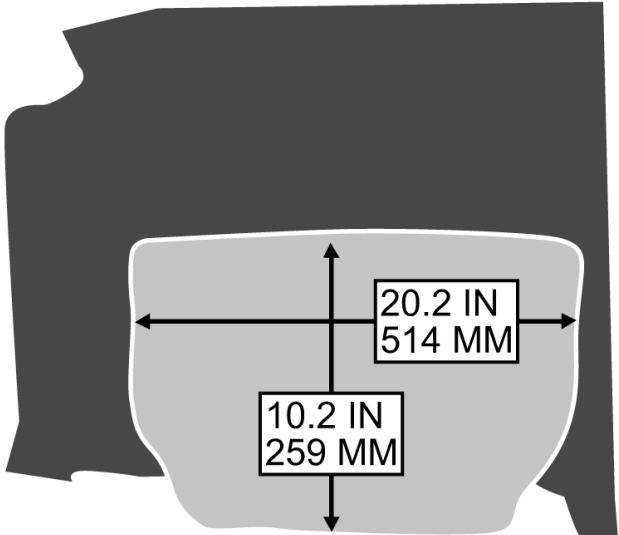

KNEE AIRBAG
FRONT VIEW FROM DRIVER SIDE

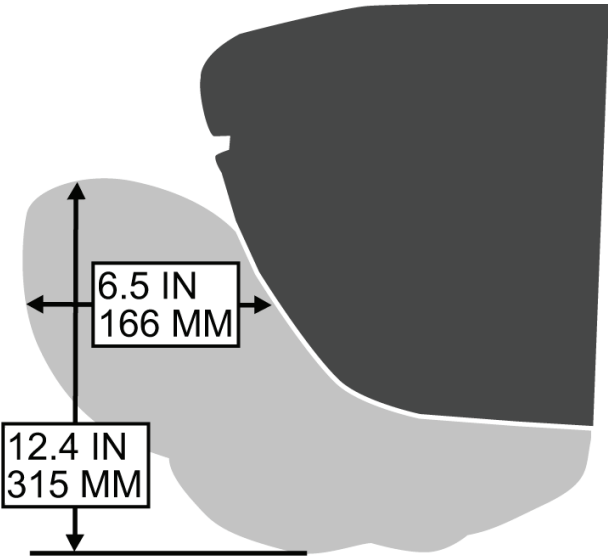

KNEE AIRBAG
SIDE VIEW FROM PASSENGER SIDE

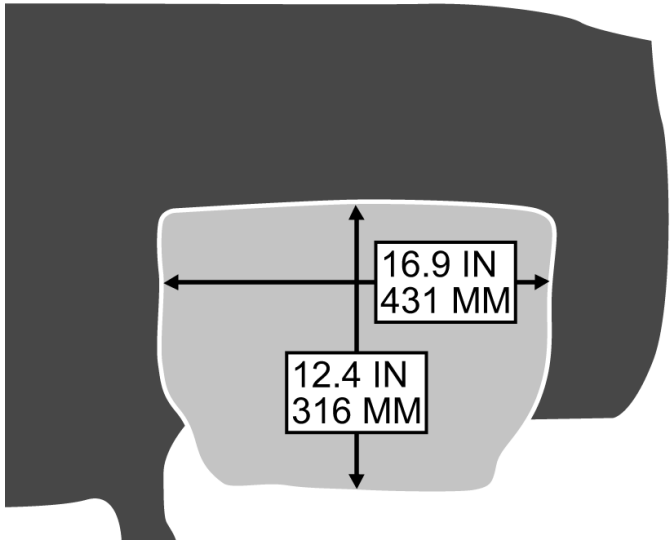

KNEE AIRBAG
FRONT VIEW FROM PASSENGER SIDE

Sitting too close to an airbag when it deploys can increase the risk of serious injury or death. Always properly wear your seat belt. See Owner's Manual for more information.

AIRBAGS FAQ

Q: Can equipment such as radar devices, video cameras, and radio trees be mounted in a specialty vehicle equipped with a right front passenger frontal airbag?

A: Yes, but care must be taken to properly mount the equipment outside of the airbag "deployment zone."

Q: What is the airbag "deployment zone"?

A: The term "deployment zone" describes the space an airbag takes up when fully inflated. Airbags need room to work properly, and anything in the "deployment zone" – such as improperly mounted equipment – can greatly affect the performance of the airbag.

Q: How can I identify the airbag "deployment zone" in my vehicle?

A: See Airbag Deployment Diagrams for more information. The diagrams provide the approximate dimensions of the "deployment zones" for your specialty vehicle. Before doing any service work, including the installation of any equipment, consult the appropriate service manual.

Q: Is it possible to shield equipment so it does not interfere with airbag deployment?

A: While shielding may protect certain equipment from being damaged or dislodged, it may also negatively affect how an airbag inflates. Therefore, we do not recommend the placement of any equipment in the deployment zone, even if shielded.

Q: Can the installation of push bumpers on the front end of the vehicle affect the deployment of the airbag?

A: It is not likely that installing push bumpers will affect deployment for the airbag as long as the vehicle structure itself is not modified. GM is not aware of any adverse defects effect on the deployment of the front airbags due to use of many aftermarket push bumpers installed on current GM police vehicles

See "Adding Equipment to the Airbag-Equipped Vehicle" in the owner manual for more information.

Customer-Installed Equipment

Before installing equipment, read the following.

Airbags inflate with great force, faster than the blink of an eye. No objects, such as shotguns, should be placed over or near the airbag covers. Equipment mounted too close to an inflating airbag could prevent the airbag from operating properly to protect the occupants or could be forced into an occupant or break and become a dangerous projectile, causing severe injury or even death. To help prevent injury and to allow the airbag to perform as it was designed, do not mount equipment inside the airbag deployment zones.

Do not attach anything to the steering wheel hub or mount any equipment within the deployment zone for the driver airbag.

Do not mount equipment on the passenger side of the instrument panel top pad deployment zone. Equipment should not be mounted on or around the passenger airbag opening because of a deploying airbag. To allow the airbag to perform as it was designed, do not mount equipment inside the airbag deployment zone.

Do not mount a security barrier such that the ends of the barrier or brackets are within the roof-rail airbag deployment zones.

Avoid installing wiring for roof-rail emergency lighting or radio antennas that may restrict the proper deployment of the roof-rail airbags.

GM approved service procedures must be followed to remove and reinstall the instrument panel to the pad to ensure proper airbag deployment.

The police vehicle has a rollover sensor mounted on the centerline of the vehicle between the driver and front outboard passenger positions. If the vehicle has individual front seats, the rollover sensor will be exposed. Do not mount equipment within 25 mm (1 in) of the rollover sensor. This may affect the performance of multiple restraint systems.

ONSTAR

POU¹ ONSTAR SECURITY - 12 Months of Service OnStar Security service is included in the price of the vehicle. Total service duration is 12 months. Non-Transferrable. Non-Refundable.

POJ¹ ONSTAR SECURITY - 24 Months of Service OnStar Security service is included in the price of the vehicle. Total service duration is 24 months. Non-Transferrable. Non-Refundable.

POK¹ ONSTAR SECURITY - 36 Months of Service OnStar Security service is included in the price of the vehicle. Total service duration is 36 months. Non-Transferrable. Non-Refundable.

POL¹ ONSTAR SECURITY - 48 Months of Service OnStar Security service is included in the price of the vehicle. Total service duration is 48 months. Non-Transferrable. Non-Refundable.

POQ¹ ONSTAR SECURITY - 60 Months of Service OnStar Security service is included in the price of the vehicle. Total service duration is 48 months. Non-Transferrable. Non-Refundable.

POV² ONSTAR INSIGHTS - 12 Months of Service OnStar Insights service is included in the price of the vehicle. Total service duration is 12 months. Non-Transferrable. Non-Refundable.

POW² ONSTAR INSIGHTS - 24 Months of Service OnStar Insights service is included in the price of the vehicle. Total service duration is 24 months. Non-Transferrable. Non-Refundable.

POX² ONSTAR INSIGHTS - 36 Months of Service OnStar Insights service is included in the price of the vehicle. Total service duration is 36 months. Non-Transferrable. Non-Refundable.

POY² ONSTAR INSIGHTS - 48 Months of Service OnStar Insights service is included in the price of the vehicle. Total service duration is 12 months. Non-Transferrable. Non-Refundable.

POZ² ONSTAR INSIGHTS - 60 Months of Service OnStar Insights service is included in the price of the vehicle. Total service duration is 60 months. Non-Transferrable. Non-Refundable.

R8G³ ONSTAR ONE BUSINESS PLUS - 12 Months of Service OnStar One Business Plus (bundle and save) includes up to 12 months of OnStar Security and OnStar Insights services. OnStar One Business Plus service is included in the price of the vehicle. Total service duration is 12 months. Non-Transferrable. Non-Refundable.

RFH³ ONSTAR ONE BUSINESS PLUS - 24 Months of Service OnStar One Business Plus (bundle and save) includes up to 24 months of OnStar Security and OnStar Insights services. OnStar One Business Plus service is included in the price of the vehicle. Total service duration is 24 months. Non-Transferrable. Non-Refundable.

R8P³ ONSTAR ONE BUSINESS PLUS - 36 Months of Service OnStar One Business Plus (bundle and save) includes up to 36 months of OnStar Security and OnStar Insights services. OnStar One Business Plus service is included in the price of the vehicle. Total service duration is 36 months. Non-Transferrable. Non-Refundable.

R8Z³ ONSTAR ONE BUSINESS PLUS - 48 Months of Service OnStar One Business Plus (bundle and save) includes up to 48 months of OnStar Security and OnStar Insights services. OnStar One Business Plus service is included in the price of the vehicle. Total service duration is 48 months. Non-Transferrable. Non-Refundable.

R8W³ ONSTAR ONE BUSINESS PLUS - 60 Months of Service OnStar One Business Plus (bundle and save) includes up to 60 months of OnStar Security and OnStar Insights services. OnStar One Business Plus service is included in the price of the vehicle. Total service duration is 60 months. Non-Transferrable. Non-Refundable.

PR6⁴ SIRIUSXM, ADDITIONAL 9 MONTHS OF THE SXM PLATINUM PLAN. Listen inside and outside the car on the app in addition to the trial period included with the vehicle.

PR7⁴ SIRIUSXM, ADDITIONAL 21 MONTHS OF THE SXM PLATINUM PLAN. Listen inside and outside the car on the app in addition to the trial period included with the vehicle

PR8⁴ SIRIUSXM, ADDITIONAL 33 MONTHS OF THE SXM PLATINUM PLAN. Listen inside and outside the car on the app in addition to the trial period included with the vehicle.

1. OnStar plan, working electrical system, cell reception and GPS signal required. OnStar links to emergency services. See onstar.com for details and limitations. Roadside services provided by Allstate Roadside Service for vehicles only. Limitations and restrictions apply. Stolen Vehicle Assistance requires armed GM factory- installed theft-deterrent system, contact method on file and enrollment to receive alerts. Additional messaging and data rates may apply. Services are intended to assist with vehicle recovery and do not prevent theft or protect against damage or loss. Requires (UEI) OnStar. Requires one of the following US Fleet or Government order types: FLS, FNR, FRC, FBC, FGO or FEF. Not available with POJ, POK, POL, POQ, POV, POW, POX, POY, POZ, R8G, R8P, R8W, R8Z, or RFH. Not available with a ship-to of Guam, Puerto Rico or the Virgin Islands. 2. OnStar Insights provides fleet managers and drivers the tools and data they need to help maximize fleet productivity and help maximize fleet's operational efficiencies. OnStar Insights relays real-time vehicle data like vehicle location, driver performance information and more. Eligible customers must sign up for an account at www.onstarvehicleinsights.com in order to take advantage of this offer. Requires an active connected vehicle services plan. Requires (UEI) OnStar. Requires one of the following US Fleet or Government order types: FLS, FNR, FRC, FBC, FGO or FEF. Not available with POU, POJ, POK, POL, POQ, POV, POW, POY, POZ, R8G, R8P, R8W, R8Z, or RFH. Not available with a ship-to of Guam, Puerto Rico or the Virgin Islands. 3. OnStar One Business Plus (bundle and save) includes OnStar Security and OnStar Insights services. OnStar plan, working electrical system, cell reception and GPS signal required. OnStar links to emergency services. Service coverage varies with conditions and location. Service availability, features and functionality vary by device and software version. See onstar.com for details and limitations. Requires (UEI) OnStar. Requires one of the following US Fleet or Government order types: FLS, FNR, FRC, FBC, FGO or FEF. Not available with POU, POJ, POK, POL, POQ, POV, POW, POX, POY, POZ, R8G, R8P, R8Z, or RFH. Not available with a ship-to of Guam, Puerto Rico or the Virgin Islands. 4. Requires (U2K) SiriusXM. Requires one of the following Fleet or Government order types: FLS, FNR, FRC, FBC, FGO or FEF. Not available with FDR order types, PR7 or PR8. Not available in AK, HI, PR and VI.

MAINTENANCE / LIMITED WARRANTY

SCHEDULED MAINTENANCE	One visit within first year of vehicle delivery ¹
BUMPER-TO-BUMPER LIMITED WARRANTY	3 years/36,000 miles ² . Bumper-to-Bumper Limited Warranty with no deductible
ELECTRIC VEHICLE PROPULSION LIMITED WARRANTY	8 Years / 100,000 Miles ²
TIRES⁴	3 years/36,000 miles ² ; coverage prorated after first 12,000 miles
ROADSIDE ASSISTANCE AND COURTESY TRANSPORTATION	Qualified Fleet Customers: 5 years/100,000 miles ³
RUST-THROUGH	6 years/100,000 miles ²
CORROSION	3 years/36,000 miles ²
WHEEL ALIGNMENT AND BALANCE	Up to 7,500 miles ⁵

1. Includes first required maintenance visit as stated in vehicle maintenance schedule. Maintenance visit consists of oil change, tire rotation and Multi-Point Vehicle Inspection. Does not include air filters. See participating dealer for other restrictions and complete details. Excludes vehicles ordered with fleet delete option RY9. **2.** Whichever comes first. See dealer for limited warranty details. **3.** Tires also covered under the Bumper-to-Bumper Warranty but are prorated based upon mileage. See dealer for warranty details. **4.** If the vehicle has a warrantable failure, see your Owner's Manual for full details on the Courtesy Transportation program. **5.** Customer maintenance item after 7,500 miles.



GM reserves the right to make changes at any time, without notice, in prices, colors, materials, equipment, specifications, models, and availability. Specifications, dimensions, measurements, ratings, and other numbers in this catalog and other printed materials provided at the dealership or affixed to vehicles are approximates based upon design and engineering drawings and prototypes and laboratory tests. Your vehicle may differ due to variations in manufacture and equipment. Since some information may have been updated since the time of printing, please check with your GM dealer for complete details. Some of the equipment shown or described throughout this publication may be available at extra cost, and/or is supplied by an independent supplier.

Copyright 2024 General Motors. All rights reserved. All text, images, graphics, and other materials in this publication are subject to the copyright and other intellectual property rights of General Motors. These materials may not be reproduced, distributed, or modified without the express written permission of General Motors. The marks appearing in this publication including, but not limited to: GM and the GM logo; Chevrolet and their respective logos, emblems, slogans, and vehicle model names and body designs; and other marks such as GM ENVOLVE and Commercial are trademarks and/or service marks of General Motors, its subsidiaries, affiliates, or licensors.

For more detailed information, contact your District Sales Manager or see the online order guide at gmevolve.com/police.

